

BCB International

Company Profile 2024



v36





Fabulous history



Browns Cough Bottle = BCB As supplied to British troops in the Crimean war

BCB History

1854

Dr Brown invented Brown's Cough Bottle (BCB) for British troops in Crimea.



1900

Brown's Cough Bottle was sold to the public in the UK.



1914

BCB Ltd. was established as a medical company, named after Brown's Cough Bottle.



1940's

First ever medical kit for life boats and rafts designed and manufactured.



1950's

First supply to the British Ministry Of Defence Browns Cough Bottle Pastilles are made.



1985

Pioneer brand of outdoor accessories developed.



1988

Winner of first Queen's Award for Export Achievement.



1980's

First supply to the United Nations.



1979

BCB International Ltd was established to develop the military range and export.



1975

Supply medical equipment to the first successful expedition to the South West face of Everest.



1967

Developed shark repellent for US Navy



1993

LRQA ISO Quality Control approval.

2007

BCB International Inc. was established in the USA.



1998

Second Queen's Award for Export



1999

Robotic R&D begins.



2009

Blast Boxers were designed.



2013

FIRE DRAGON eco-friendly cooking fuel developed.



2015

Development of FATS - Floating Body Armour System



2014

BCB Adventure created for the outdoor market.

2019

Adapted FireDragon for NHS as Hand Sanitiser



2017 - Present

Boat Stopping & Mine Clearance Systems Development



2021 - Present

UAV Systems



Meet the team

BCB International Ltd. Company Overview

SALES

OPERATIONS

SUPPORT



CUSTOMER

MARINE SALES

Business Development



Stephanie France-Davies
sh@bcbin.com

Business Development



Stuart Morris
sm@bcbin.com

Humanities



Fergus Lynch
flynch@bcbin.com

DEFENCE SALES

UK

Business Development



Maj John Richards
jrich@bcbin.com

Head of UK Military Sales



Paul Ames
pa@bcbin.com
UK Military Sales Manager

Business Development



Pete Bolam
pbolam@bcbin.com

Business Development



Vida Varada
vvarada@bcbin.com

EXPORT

International Defence



James Wesley II
jw2@bcbin.com

ROW



Ben Silmon
bs@bcbin.com

Defence



Emily Howel
eh@bcbin.com

Sales Admin



Dermie Arnold
da@bcbin.com

Ukraine



Julia Ptas
jptas@bcbin.com

Ukraine



Col JTI Volodymyr Ruschik
vruschik@bcbin.com

Defence



Margal Sharet
ms@bcbin.com

RETAIL SALES

EU Leisure



Becky Rastiffe
br@bcbin.com

Business Development



Paul Davitt
pd@bcbin.com

Business Development



Morgan Jones
mjones@bcbin.com

ACCOUNTS DEPARTMENT

Head of Accounts



Diana Fross
dfross@bcbin.com

Accounts Assistant



Kyla Deegan
kd@bcbin.com

Accounts



Jane Ryan
jr@bcbin.com

PURCHASING

Purchasing Manager



Adnan Haddad
ahaddad@bcbin.com

Buyer



Dhivesa Williams
dwilliams@bcbin.com

QUALITY CONTROL

Quality Manager



Willem Huib
whuib@bcbin.com

Quality Assistant



Lorlay Bakst
lbakst@bcbin.com

Quality Control



Adam James
ajames@bcbin.com

OPERATIONS

Operations Manager



Lisa Owen
lo@bcbin.com

PRODUCTION

Production Manager



Sue Row
srow@bcbin.com

Packing



Steve Seart

Supervisor



Sarah Meah

Supervisor



Garth Griffin

Supervisor



Ananda Wilcox

ENGINEERING

Mechanical Engineer



Jonathan Swat
jswat@bcbin.com

Electrical Engineer



Robert Taylor
rtaylor@bcbin.com

DESIGN & DEVELOPMENT

R & D Manager



Leah Thomas
lthomas@bcbin.com

R & D Designer



Alex Smith
asmith@bcbin.com

Chemistry



Katie Reichwald
kreichwald@bcbin.com

Graphic Designer



Deri D'Amali
ddamali@bcbin.com

Junior Graphic Designer



Megan Jones
mjones@bcbin.com

COMMUNICATIONS

PA to Director



Kelly Humphreys
khumphreys@bcbin.com

DIRECTORS

Director



Andrew Howell
ah@bcbin.com

Director



Janey Howell
jhowell@bcbin.com

TRANSPORT

Despatch



Gavin Jenkins
gjenkins@bcbin.com

Despatch



James Brown
jbrown@bcbin.com

Goods In



Jay Hall
jhall@bcbin.com



2 Modern manufacturing factories



**Secure 3-acre
freehold factory.
Close to city centre
And M4, (A48) motorway**



52,000 sq. ft. efficient factories



Officially opened
by
HRH Prince
of Wales





Prime British Manufacturer.

Eco fuel production - FireDragon



Camouflage Cream

Creams – liquids - powders



Sewing & heavy textiles



Kits & Packs



Responsive manufacturer



- ✓ **British quality**
= right first time
= sustainable
- ✓ **UK & EU standards**
- ✓ **Assured supply chain**

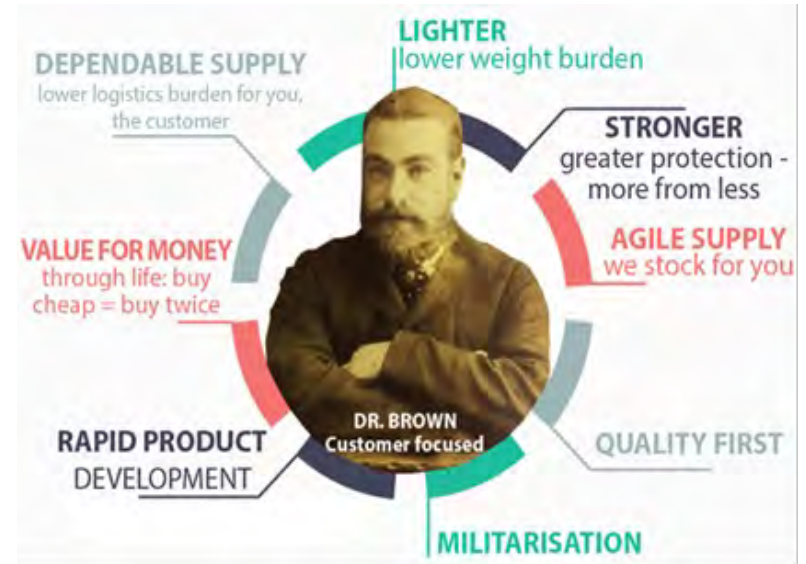

BCB pride ourselves on having the best products, ready and available to meet the needs of the rapidly changing military, political and social arenas worldwide. If new products are needed, we innovate, design and develop to bring solutions to market.



Focused growth markets

Well established customer relationships.

Respected brands

High quality innovative products

Defence 75%

Marine 13%

Outdoor 12%

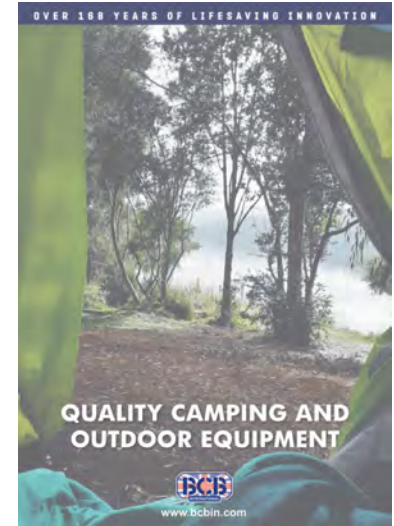

Core Markets

Delivery record = 95% on or ahead of time (KPI = 98%)



Quality Assured

QUALITY ASSURED
ISO Approved to since 1993

SOLAS approvals

LRQA
CERTIFIED

ISO 9001 · ISO 14001



ADS

- Accredited to ISO 9001:2015 & ISO 14001:2015
- ISO Approved to since 1993
- Over 400 N.A.T.O. approvals



Award Winning

- ✓ 2 x Queens Award for Export
- ✓ 3 x Soldier Technology Awards
- ✓ Best Company to work for, Sunday Times
- ✓ 2 x Welsh Innovation Awards
- ✓ Business Language Champion
- ✓ Special Recognition Award

MANUFACTURER OF THE YEAR





Impressive Customer Base

Good customer penetration throughout Europe Sales to over 50 countries with regular repeat business.

35% export sales

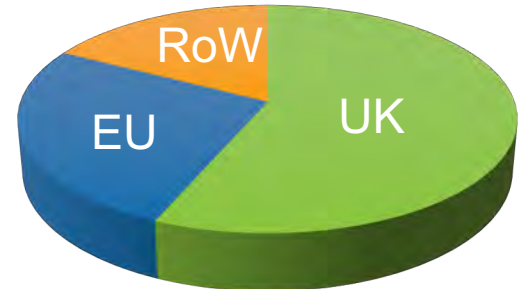

Global Sales



Quality Customer Base

PRIME CONTRACTOR

With long-term relationships across Military, Marine & Leisure sectors, including relationships lasting over 60 years with DE&S, the UK MoD, and RFD.





BCB Forward Figures

2 NEW + 2 REVAMPED RANGES

ACE	RETAIL	MS CAMO	UAV'S
-----	--------	---------	-------

CORE CONTRACTS LONG TERM @2-5 YEARS



£5M+P.A.

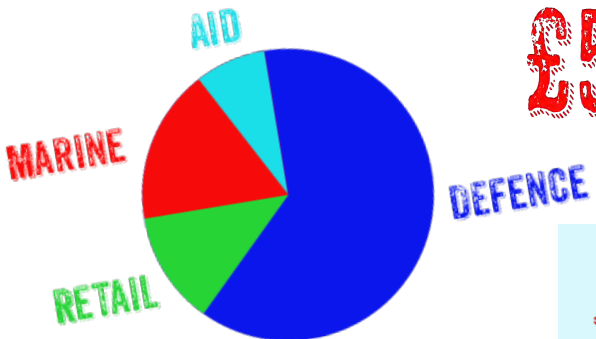
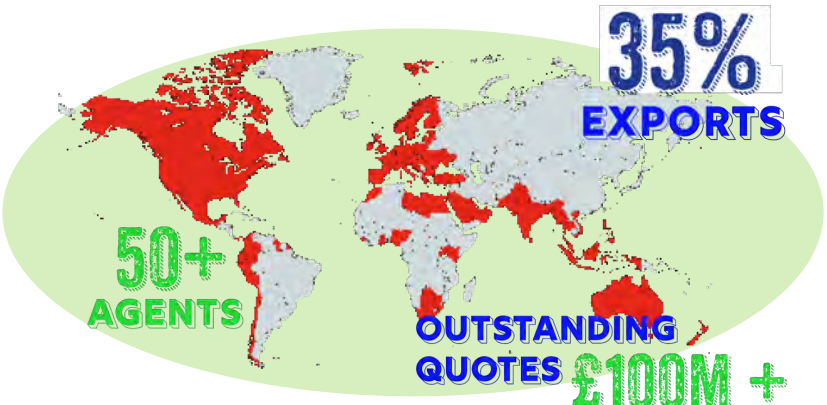

4 SOLID MARKETS



£1.29M INNOVATE GRANT



FIREDRAGON

FOR PLANT IN UKRAINE BCB PART £407K





✓ BCB = ESG

Meeting Environmental, Social & Governance standards



- Quality product made in Britain
- Supply Chain security by local re-shoring manufacture
- So not let down by international supply restrictions
- Regular supply chain monitoring and closed managed
- Local R&D = rapid product development with British Universities
- Family owned, managed, and friendly family feel
- UK taxpayer, exporter, and equal opportunities employer
- Cyber secure



- **Has saved the many tonnes of CO, CO2, NO, PAH, methane and cyanide.**
- Prime manufacturer of clean green eco-friendly products
- Repair/refurbish capability = recyclable = *lower through life costs.*



- Regular supply chain reviews.
- **BCB is a fair and sustainable employer**
- Support local and international charities

Keep it local; make it British!





CANEI attitude = Continuous And Never-Ending Innovation

- Millions invested into R&D in the last few years
- Collaborative University and Business partnerships
- Diverse expertise.
- Rapid prototyping.
- Lifetime, invention, trialling, innovation and manufacture.
- Retired military personal

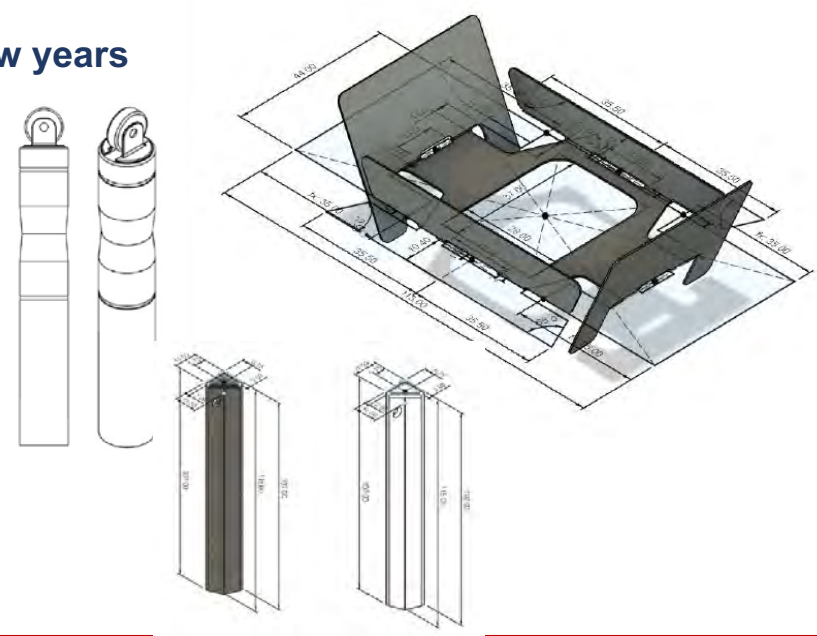

Some of our new or developing products



Mini Cooker MK2



Crusader Cup Lid



Folding Field Desk



Heating Kits



Solid Eco Fuel



Defence – core market

DELIVERY RECORD:
95% on or ahead of time
KPI = 98%

Highly innovative product range trusted by our military customers

BCB have a long history of serving the UK military market with the UK MoD and MoJ's as significant customers.
BCB's owns the IP protection for 9 innovative products.

Command Tents



Field Furniture



Multi-Spectral
Camo systems



Fire Dragon
Mini Cookers



Camo Cream



Floating Armour
Torso Systems



Fire Dragon
Eco Fuel



Boat Stopping
System



IR Thermal
Camo net



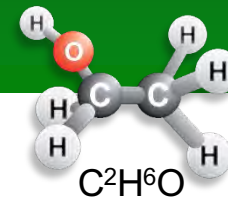

ECO FRIENDLY FUEL FOR THE FUTURE. GREEN & CLEAN

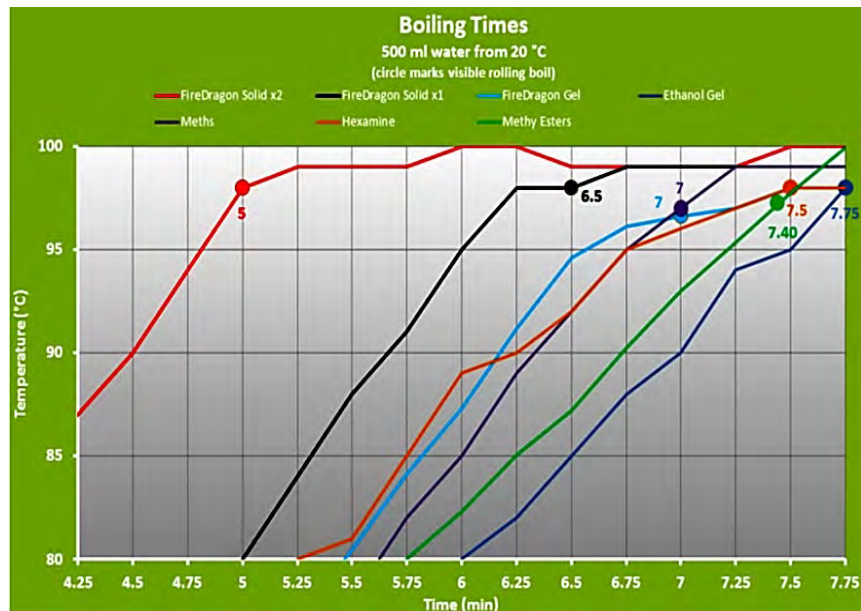

Fuel for the future

- ✓ Sustainable
- ✓ Cooks quickly
- ✓ Burns intensely
- ✓ Easy to light
- ✓ Nontoxic
- ✓ Safe to carry/transport
- ✓ Almost no soot produced



In extensive field and laboratory testing by the British Army, FireDragon proved to be the best of all solid fuels tested



Hand Cleanser



All-Weather



Quick & Easy to Light



Clean Burn



FIRE DRAGON

High Performance
Eco fuel

Water resistant and easy to ignite with a single spark

Environmentally-friendly solidified ethanol

Can be packed safely with food

Fast boil and long burn – high heat output

Clean burn; very few green house gases given off.

Air transportable

Safe to burn in enclosed spaces

Also effective as a hand sanitizer

Can be used in a range of existing cooking systems

"The small FireDragon tablets are easy to use and fit perfectly into my survival tin and mess kit"

Sgt, Special Forces



Non toxic. Natural ingredients

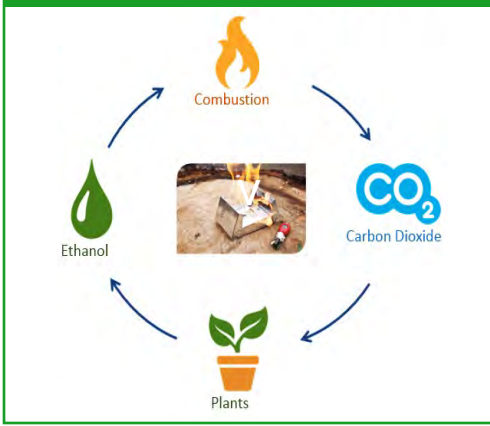

Worldwide patent



FireDragon is more efficient (28MJ/Kg) than kerosene, methylesters and paraffin.



Field Cooking Systems & Eco Fuel

- Designed for efficient air intake whilst shielding against the wind
- Wind shield and heat exchanger
- Multi-fuel capability
- Fast boil time
- Compact, lightweight and robust
- Fast and efficient field cooking therefore low fumes, soot, CO, NO, CO₂ and Methane



**Works perfectly
with FireDragon
Eco fuel**





World leaders in Camo Cream

BCB manufacture for most NATO forces and are the global leader in camouflage cream.

- Non-irritant and non toxic
- Infrared Reflective (IRR)
- Available in compacts, sticks and tubes
- Not affected by rain or sweat
- Easily removed with soap.
- High sun protection factor



**We have been manufacturing camouflage cream for more than 35 years
Ours is the only cream in the world which is proven to be Infrared Reflective (IRR).**



Tube



Compact



30 & 60g Stick

BCB have made MK7 camo nets for over 15 years for the UK MoD in conjunction with The Ministry of Justice.

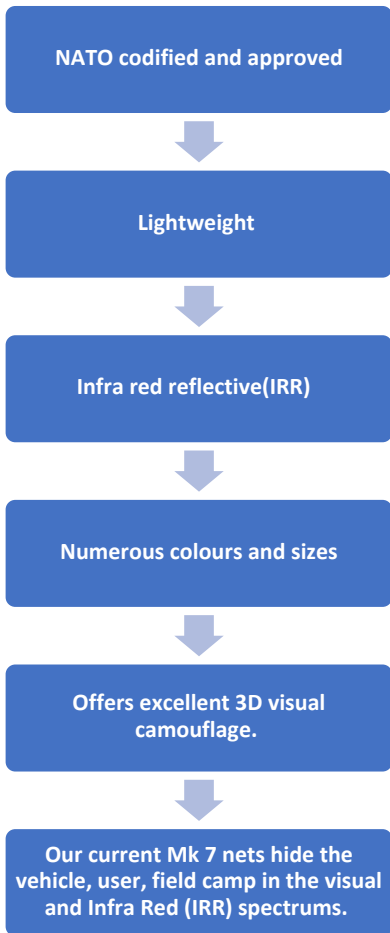

Our camo nets will camouflage/protect the user from modern thermal optics, which are currently being used to terrible effect in the Ukraine.

It will hide vehicles, field camps and personnel from the modern optics on their drones in the visual, near (NIR), short (SWIR), medium (MWIR) and long range infra-red (LWIR) spectrums.

A range of nets would be needed as no one net fits all climatic conditions or user needs.

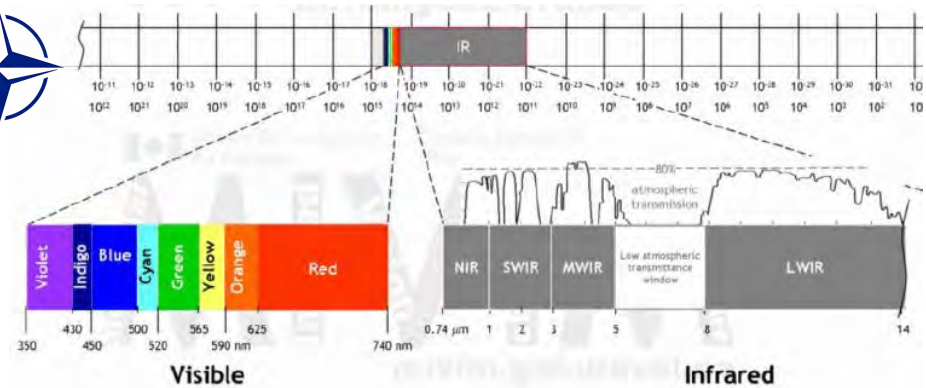

Infrared spectrum (400 – 1200)
Thermal spectrum • Visual spectrum

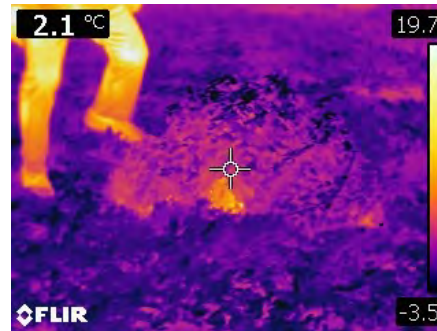

Above: Our subject lay under a sheet, looking out

Woodland Moorland / Mountain Desert Urban Snow



Patterns, colours and sizes can be customized according to customer requirements

The Mk8 is very effective from visual through hyperspectral to broadband/multispectral spectrums and gives an excellent emissivity reduction.



BCB's next generation MultiSpectral Cam (MSC):



- Camouflages in **visual, thermal and infra-red spectrums**
- Robust
- Lightweight
- Fire retardant
- Reversible
- 3D to break up outline
- Options for different terrains and sizes

Mobile camouflage



Platform static camo cover



Personnel

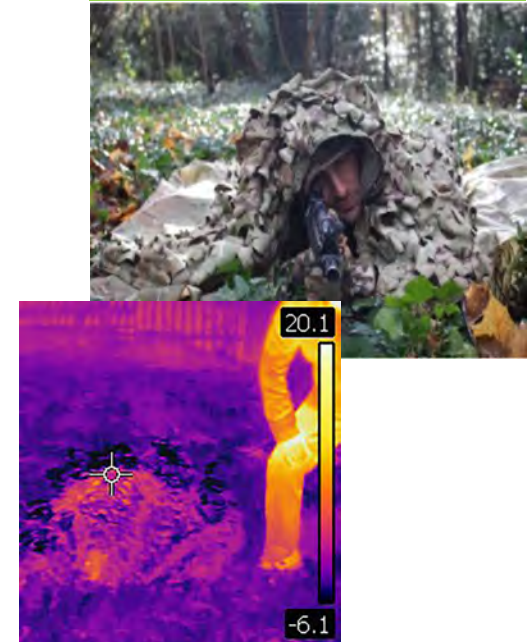

“Thermal Image (TI) Properties.

The ability of the CAMNET to conceal against TI was found to be excellent.

The image below was captured from a MOSQUITO thermal optic. Only the front portion of the HMTV is visible as the CAMNET was purposely raised to show a comparison between areas of the vehicle that are covered.

Note the net held in position by rocks due to the nature of the terrain.”

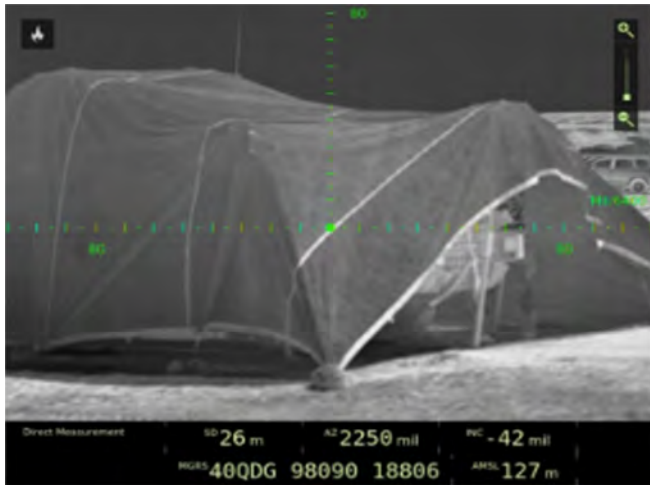

“This material can also be further enhanced with an additional semi-rigid lightweight material, which provides extra thermal protection.”

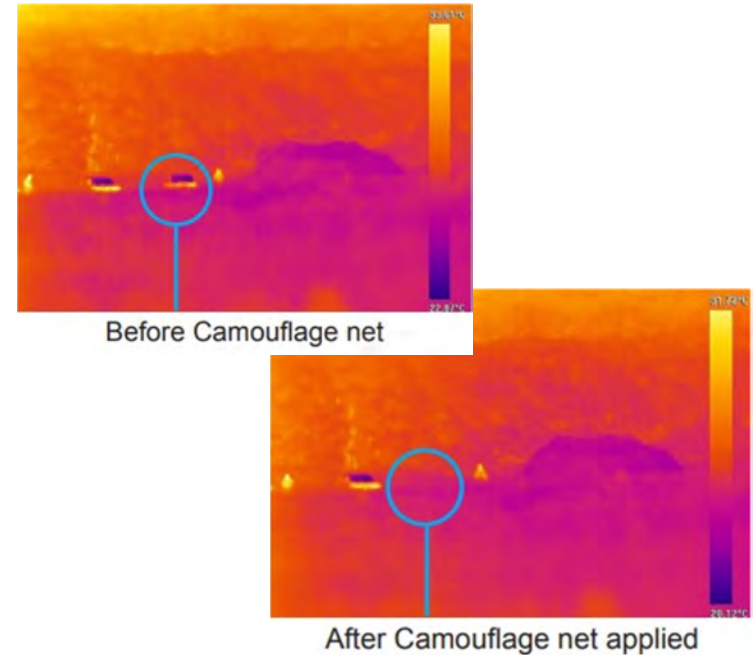

Mk8 Multi-spectral SMS protects the wearer in the visual, infrared (NIR & SWIR) and thermal spectrum's (MWIR & LWIR)

Used in the field by snipers/observation posts. Quiet, lightweight and easy to carry, it provides concealment from drones and advanced lenses.

- Designed to defeat Intensifier & Thermal optics
- Wired hood for ease of opening/closing
- Easy to move around in, quick to don and doff
- Breathable for comfort, low snag liner
- Anti Radar, water repellent finish
- Double-sided print (note only one side is 3D)

2 piece set - poncho and trousers

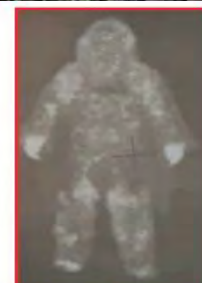

Hood Open

Hood Closed



Rock material.

- Similar spectrum protection to Sniper suit
- Double sided
- Light, 650g/m²
- Size 2mx3m packs to 30cm x 50cm



Mobile Multispectral (Vehicle) Camo (MMSC)

- Attaches to the vehicle.
- Easy and quick to change colours
- Safely allows relocation of Vehicles to redeploy
- Bespoke MSC panels
- Velcro-magnetic attachments
- Customised to allow access to all areas



NEW DESIGN



UK-MOD Crown-Copyright 2022

New MOD Military Vehicle on test using BCB camo livery

BCB's innovative Natural 3D/MS Camo

A new lightweight 3D material that can be used as camouflage netting and in signature management suits.

PROPERTIES

- Operational temperature range : 45°C_+70°C.
(EN 60068-2-2 / EN 60068-2-1)
- Fire resistance (ISO 6941)
- Resistance to Petroleum Oil: No deformation
- Washing Fastness: ≤ 4/5 ISO 105 C01
- Water Fastness: ≤ 4/5 ISO 105 E01
- Rubbing Fastness (dry) : ≤ 3 ISO 105-X 12
- Tear Resistance: Warp: 24 N Weft: 23 N
(DIN EN ISO 13937-2)
- Breaking Resistance: Warp: ≥ 288 N Weft: ≥ 282 N
(DIN EN ISO 13934-1)
- Air Permeability: 2398,5 mm/s
(EN ISO 9237)

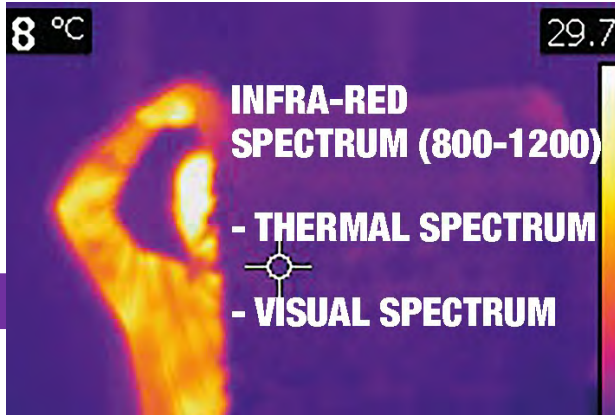

Unique crinkle texture blends better with nature

NEW DESIGN



RAPIDLY DEPLOYED CAMO SCREEN

BCB's newly developed Natural 3D/Multispectral Camo

This concealment ensemble is made from a new, specialised lightweight, wearable material that helps the wearer blend into any natural environment whilst protecting them in the RADAR, INFRARED and THERMAL spectrums

FABRIC FEATURES:

- 3D 'Crinkle' pattern blends with nature.
- Non-s snag & breathable.
- Quiet and Lightweight.
- Fire Retardant & quick drying.
- OT range: -45°C to +70°C.
- WEIGHT: 2.07kg



Comfortable against the skin for long periods

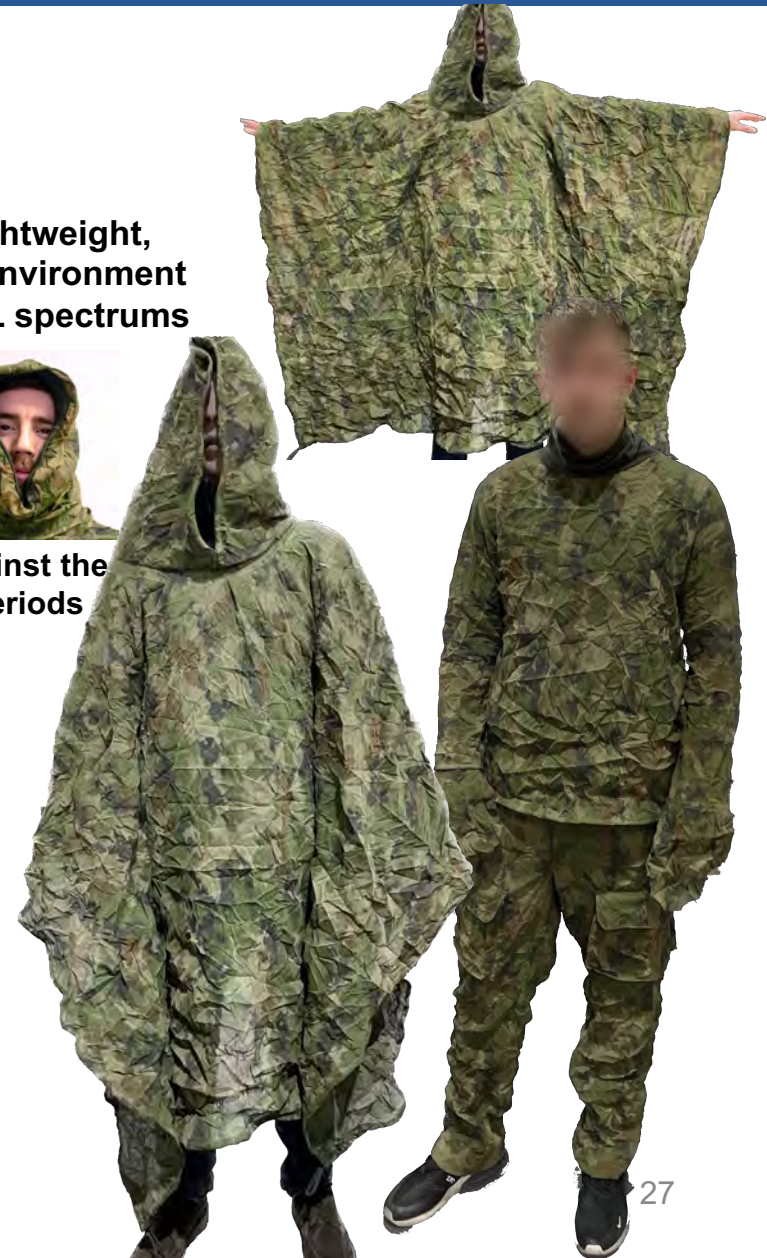

Location Marker Balloon

- Designed by the military for the military.
- Can be quickly used to mark your Drop Zone position or if in need of rescue.
- Tethered high above any jungle on a 75 metre Kevlar cord
- Can be operated by one person within minutes
- Uses inert helium gas to inflate 136 litre Radar Reflective balloon
- Lightweight carbon fibre cylinder
- Large 1 meter balloon
- Day/night visible
- Radar Reflector
- Reusable





Fox Sleeping System

- Comfortable, compact and versatile
- A modular 3-in-1 jungle shelter system that can be combined or used independently
- Developed in conjunction with Special Forces



1. Forest Hammock

A generously sized, parachute grade, ripstop nylon hammock

3. Jungle Mosquito Net

A rugged, close weave polyester mosquito net. Clipped to fabric loops.



2. Lightweight Waterproof cover (Basha)

A lightweight robust shelter sheet forming fully tape-seamed and reinforced points.

- Compact and lightweight
- PU coated Ripstop Nylon
- NATO approved



CASEVAC SLIDE

RAPID
ARMOURED VEHICLE
EVACUATION

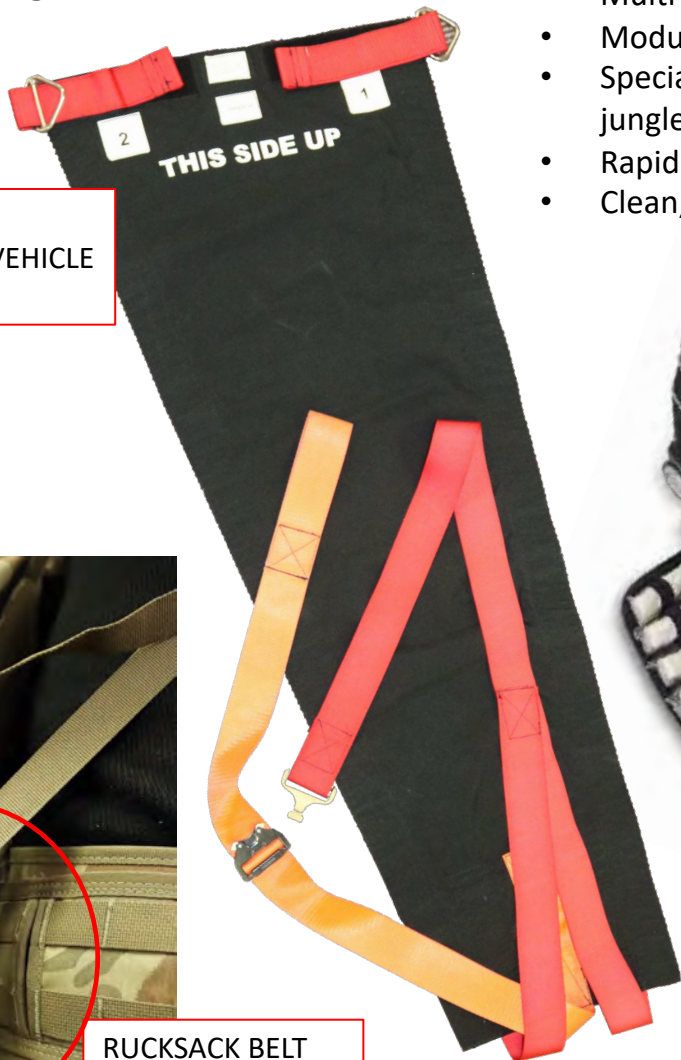

RUCKSACK BELT
QUICK-RELEASE
MECHANISMS



- Multi-functional and configurable
- Modular & integrated
- Special roles – airborne/maritime/ jungle to artic
- Rapid prototyping
- Clean, repair and renew in UK



MEDIC
TROLLEY
BAG

Honeycomb
internal layout
with removable
dividers.



Multi compartment
MEDIC THERAPY
TROLLEY with wheels

- Mesh Pocket
- 4 Detachable COLOUR-CODED Compartments, with handle.
- Three transparent pockets that allow the easy identification



FATS (Floating Armour Torso System)

A unique, versatile floating body armour incorporates a life jacket with both soft and hard armour. Low bulk and close fitting.



- Life jacket protected from bullet and fragmentation attack
- Automatically inflates within 3 seconds of water immersion
- Can be deactivated allowing diving up to 20m
- Reusable
- Waterproof armour
- Available in 2 variants:
 - Low Profile (175 Newton) for air crew or vehicle crew or High Buoyancy
 - (275 Newton) for Marine/Navy/Coastguard and Marine Police

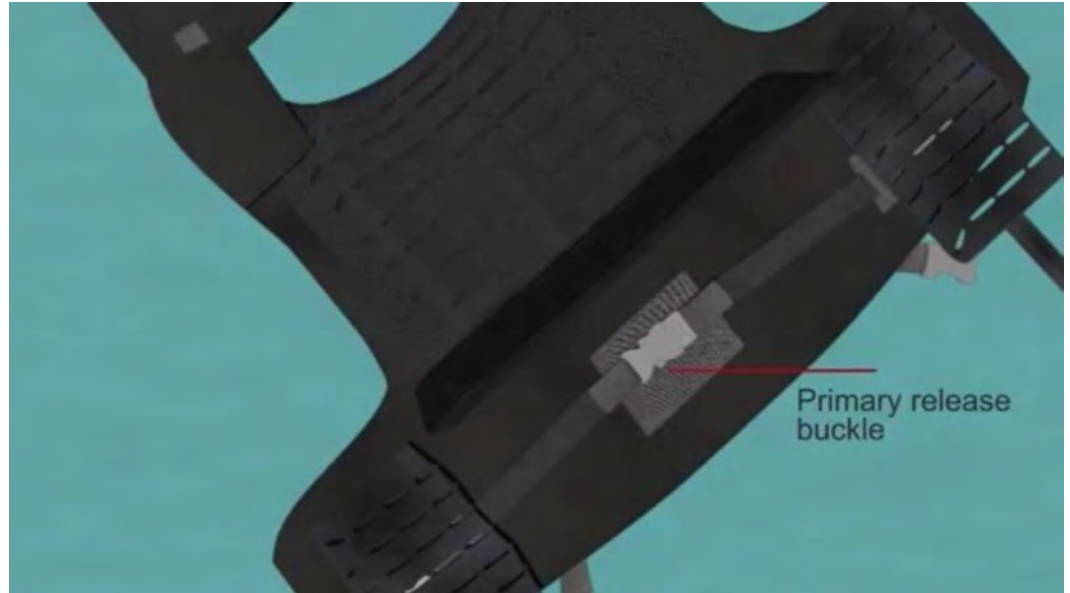

Options:
Black
Camouflage





Blast Boxers

- The original patented pelvic protection
- Sculpted design - increased comfort
- Breathable fabric
- Laboratory and field tested
- Fire Retardant
- Anti-microbial and anti-odour
- No ballistic degradation following washing
- US Berry compliant – MADE IN THE UK and USA



Performance – Tested in accordance with MILSTD – 662F | V50 2gr RCC



Inner thigh
= 910 ft/s [227 m/s]



Upper front & back
= 910 ft/s [227 m/s]



Genital region
= 1020 ft/s [311 m/s]

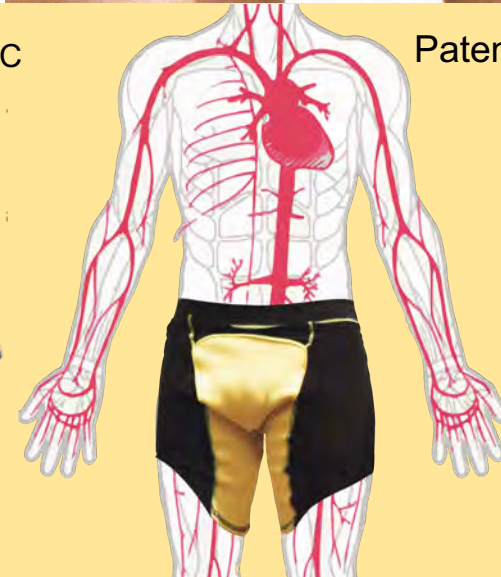

Patented Design

Protects
the
Femoral
Arteries

PMEK – Personal IED and Mine Extraction Kit



- Compact
- Reliable components.
- Easy to access
- MOLLE belt attachment.
- For every soldier to carry.



Can be opened with one hand.



SAFE Lane: Rapid Obstacle Clearing Kit

Light-weight
quick assembly kits
to clear Battlefield
Obstacles



- Pouch / Pocket to use in seconds
- Safe, quick to arm/dis-arm
- Effective and modular
- Lightweight
- Variable length and Explosive Weights

It Will Breach

- Paths, Doors, Walls, Fences, Gates
- Placed Obstacles / Hasty Obstacles
- Mines, Weapons Caches

The “Obstacle-Clearing kit” comes with everything required to clear small field expedient and deliberate obstacles, such as: concertina, mines, fencing, barbed wire and other battlefield emplacements.

It is lightweight and fits into a small manpackable belt pouch.

Simply add explosives, such as a detonation sheet, C4 or a slider charge.





Dragon Mk3

– A well-proven, versatile and mission-ready UAV Platform.

- FLIGHT TIME: up to 10 hours
- FLIGHT RANGE: 500 kilometres (2-way)
- PAYLOAD: up to 25 kilograms



Dragon-15
Wingspan:
3.8 Metre
Payload 15Kg.

Dragon-25
Wingspan:
4.5 Metre
Payload 25Kg.

Markets:

- Defence
- Security
- Mining
- Environmental and
- Science Industries





UAVE Ltd



**STRONG,
VERIFIABLE
COMMERCIAL
INTEREST FROM
DEFENCE
MARKETS**

**FOUNDED
2013**

**BASED AT
WEST WALES
AIRPORT**



**RESPONSIBLE FOR
WORLDWIDE
SALES**

UAVE LTD

www.uave.co.uk

**GLOBAL
MILITARY DRONE MARKET is
projected to grow
at a CAGR of**

14.1%

In 2023-2030 Period

**UAVE RESPONSIBLE FOR
DRONE FLIGHT SERVICES
BUSINESS FOR A
REGULAR INCOME
STREAM**

**FY Predicted
Turnover '2024**

£2.4

Million



Investment in UAVE Ltd



Investment in UAVE Ltd.
a drone manufacturer in Wales.



Market Status

The drone/Unmanned Aerial Vehicle (UAV) market continues to expand rapidly. Due to the market potential, we have bought a 9% holding in UAVE Ltd a small loss-making drone designer and manufacturer.

We have the exclusive worldwide rights to sell their fully proven tried and tested Dragon 15 fixed wing UAV Platform. UAVE retain the rights for service sales. Other USPs for it include:

- **Long flight endurance**
- **Heavy payload-15 kilos (with a 25 kilo payload option)**
- **Can fly in a GPS deigned airspace.**
- **British design and manufacture.**

UAVE and BCB have also invested in developing a new fixed wing and VTOL (Vertical Take Off and Landing) hybrid product; the Buzzard. First flight expected February 2024.

The current sales leads confirms genuine interest, from Ukraine Defence Agency Procurement, UK MoD (last trials were in November '23) and NORCE (Air Force) Nigeria. Plus numerous other interested parties.



Prion Mk3 D15

MK3 Dragon-15 with skids taking off from mobile launcher





Buzzard hybrid Fixed wing/VTOL

Wing design maximizes stability and heavy wing loading for the small VTOL platform = LOW stall speeds, high max EFFICIENCY, a large payload CAPACITY and HOT SWAP features, detachable equipment compartment and the LONG ENDURANCE gasoline engine power system.

This equates to less energy expended and more time in the air.

- Ideal combination of high energy density gasoline and high efficiency electric motor
- Complete composite construction using carbon fiber and Kevlar on a rigid honeycomb core structure
- New fuselage design concept that conceals all avionics cables
- Robust structure engineered to industrial quality
- Redundant power system for flight controller to maximize safety
- Compatible with PC-based, full-featured, Prion Mk 3 autopilot system
- Built in 6 to 8L fuel tank.
- Easy to assemble in the field, no need for expert skill. Can be assembled in 15 minutes.
- VTOL to suit virtually most surveillance missions

Payload = 3 to 109 kg
ENDURANCE = 3 hrs (Motor) to 5 hours (Endurance)
SPEED = 100 to 120 km/hour
ALTITUDE = 13,120 ft (maximum)
MTOW = 40 kg

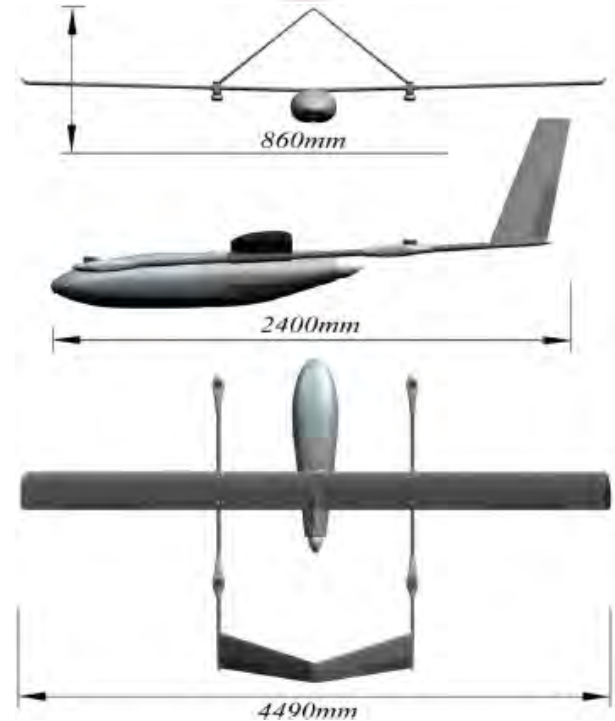

Example: UKRAINE only

Prion MK3 Dragon 15



MK3 Dragon 25





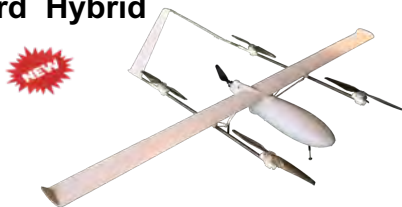

Buzzard Hybrid



Selling £`000*					Selling £`000*
300	10	1	10	10	9,300
400	10				4,000
90	10				900
TOTAL					14,200

*Airframe price only. Payloads will be extra.

Customer name	Product name	Price per item, EUR	Selling price per item, EUR	Quantity	Contract amount, EUR	Value, EUR	Time of contract	Notes and comments
Administration of the State Border Guard Service www.dpsu.gov.ua/en 	MK3-Dragon 15	200,000 €	350,000 €	10	3,500,000 €	1,500,000 €	2nd quarter 24	Much will come from the British partners of the Ukrainian border guards. They must contact us somehow. Apparently after the New Year. The positive thing is that Ukrainian colleagues promised to write the technical characteristics of the UAV that they need. Also, Ukrainian colleagues asked to test some of our products. Ref.letters dated December 20 and 22.
	MK3-Dragon 25	300,000 €	450,000 €	10	4,500,000 €	1,500,000 €	3rd quarter 24	
	Buzzard VTOL	60,000 €	100,000 €	10	1,000,000 €	400,000 €	3rd quarter 24	
Ukrainian state-owned foreign trade enterprise. SpetsTechnoExport (STE) www.spetstechnoexport.com 	MK3-Dragon 15	200,000 €	350,000 €	1	350,000 €	150,000 €	2nd quarter 24	We are awaiting an official letter from Spetstechnoexport about their readiness to organize testing of the MK3 Dragon 15. They can purchase goods in the interests of the Main Intelligence Directorate for their budget.
Defence Intelligence of Ukraine www.gur.gov.ua/en.html	MK3-Dragon 15	200,000 €	350,000 €	10	3,500,000 €	1,500,000 €	3rd quarter 24	During the tests of Dragon 15, which will be organized by Spetstechnoexport, representatives of the Main Intelligence Directorate will be the main experts and customers. Based on the test results, it is planned to place an order for a UAV.
Ukrainian-Taiwan Initiative Organization UTIO. Eduard Lanovik 	MK3-Dragon 15	300,000 €	450,000 €	11	4,950,000 €	1,650,000 €	3rd quarter 24	There is an opportunity to develop this direction from Edinburgh, since persons interested in the success of this transaction are here and can influence a number of processes in Ukraine
	MK3-Dragon 25	200,000 €	350,000 €	15	5,250,000 €	2,250,000 €	4th quarter 24	
State Enterprise Specialized Foreign Trade Firm "Progress" www.progress.gov.ua/en/ 	MK3-Dragon 15	200,000 €	350,000 €	10	3,500,000 €	1,500,000 €	2nd quarter 24	There is hope for more fruitful interaction with this organization. In 2024 we will write them official proposals.
					Contract Sum	Value Sum		
					26,550,000 €	10,450,000 €		



VTOL UAV Range

Expanding UAV range with Drone Evolution.

BCB currently supply to Ukrainian market 3 types of British made quadcopters, included lightweight and low cost FPV drones.

All are capable of flying in GPS deigned airspace. BCB have exclusive rights to sell these proven technologies in Ukraine & Iraq.

Within range are 3 Models targeted at current markets:

- **Runner** - autonomously programmed, low cost UAS, for small payloads.
- **Sentinel** - Tethered Drone System can stay in the air for hours at a time.
- **Scimitar** - small but mighty weather resistant drone- well priced.

Drone Evolution (DE) is one of the leading suppliers of drone-based services within UK and a major player in the tethered drone and specialist powered markets with a global capability to deliver tethered drones.

R&D department of DE actively utilizing feedback from end users in Ukraine with active support of BCB. So, DE produce best innovative products that suits growing market demands, as well as features for standard packages.

The current sales leads confirms genuine interest, from Ukraine Defence Agency Procurement, Administration of the state Border Guards Services, JSC Meridian in N.P Korolov, Defence Intelligence, collaboration opportunities within defence companies and from Iraq.



Representatives of BCB int & Drone Evolution during humanitarian demining forum Security 2.0 (Kyiv, Oct, 2023) shown Runner & Scimitar drones



By powering the drone via a tether, attached to a ground station, the drone can stay in the air for extended periods of time.





New range – Small Drones for Big impact

Core models



RUNNER

AUTONOMOUS DELIVERY

- Simple operation
- Auto terrain follow
- Rapid deployment
- Weather resistant
- Secure - no data gathering
- Resists RF jamming
- Acts as a radio mast
- 1.2 kg payload - 50km
- 3.5 kg payload - 20km

SENTINEL

TETHERED DRONE

- Runs directly from vehicle:
 - fixed battery
 - idling vehicle (12volt or 24volt)
 - mains
- European-made drone
- Weather-proof
- Lightweight and flexible
- Rebroadcasts
- Payload agnostic
- Resolves a blackspot
- Extends radio network

SCIMITAR FPV

FAST & SAFE

- Weather resistant
- Simple operation
- Rapid Deployment
- Small frame
- 2 kg payload
- 15 km range
- 15 min flight time
- >120 km / hour speed

SCORPIO FPV

PROGRAMMED TARGETING

- Rapid assembly
- 2 kg payload
- Range 12-15km
- Flight time: 15 minutes
- 120Km / hour speed





SENTINEL Safer to Use: NO Flyaway

- **RUNS FROM:**
 - ✓ Fixed battery
 - ✓ Idling vehicle (12volts or 24volts)
 - ✓ Mains power
- **European-made drone system**
(i.e. No significant Chinese parts)
- **Weather-proof, lightweight and flexible with high wind resistance**
- **Suitable for every military and government agency** (including the US)
- **Payload agnostic for ultimate flexibility**
- **Proved effective at communications rebroadcast**
- Wipes out a blackspot
- Extends reach of the radio network

RUNNER Autonomous Delivery-NO Jamming

- 1.2 kg of payload up to 50 km
- 3.5 kg up to 20 km (Up to 5 kg, if Upgraded)
- Simple operation and Rapid deployment
- Select co-ordinates from any smart device (no app required)
- Select required height and "GO"
- Drone flies to selected location
- Follows terrain automatically
- Weather resistant
- Total security - no onboard data gathering
- No radio frequency - resistant to RF jamming
- 'Mast Mode' feature - Runner acts as a radio mast for 1 hour





Several **RUNNERS** carrying radio repeaters at 200 metres



They rebroadcast the signal to the **SCIMITARS**



Power of the radios can be increased far above that used at ground level

Overcome radio jamming

Ensure more accurate targeting

RUNNERS

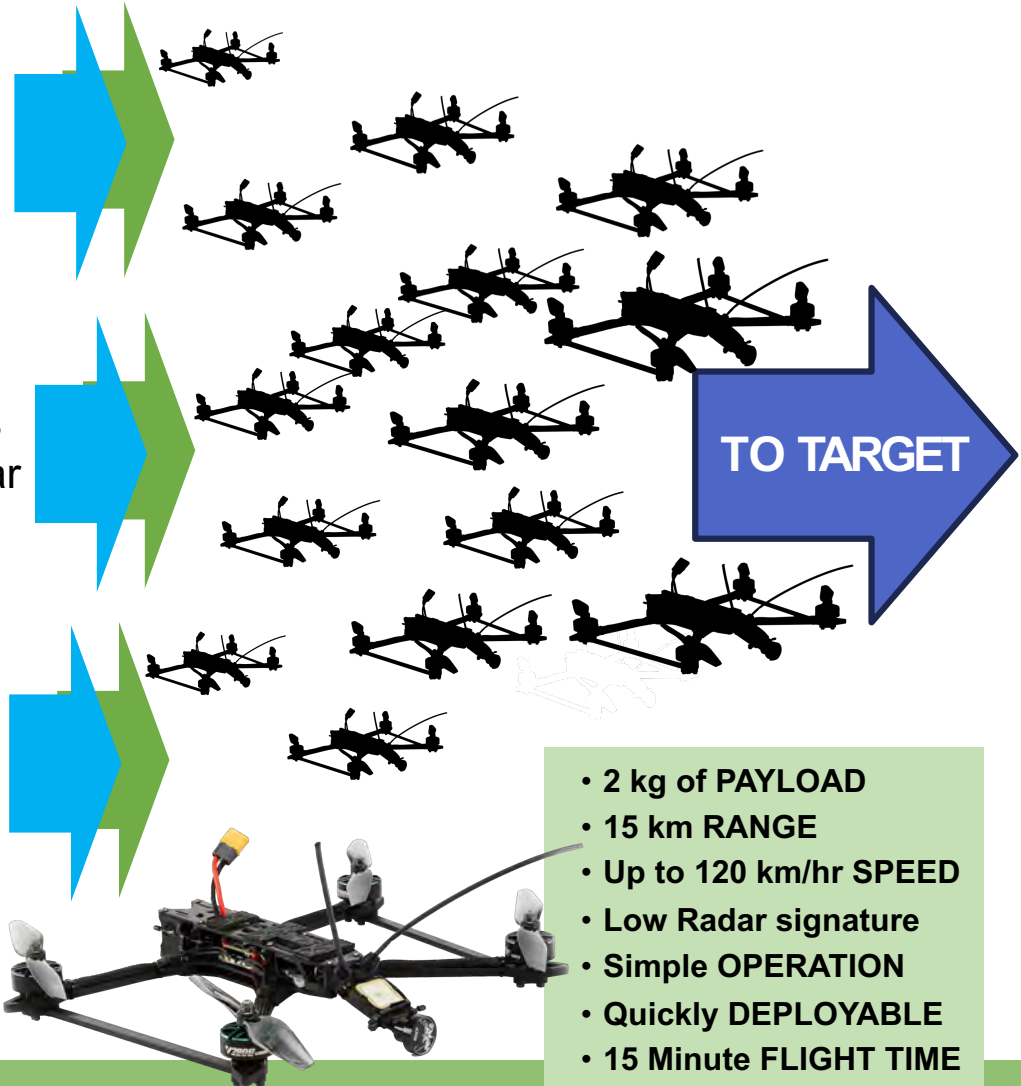

- 2 kg of **PAYLOAD**
- 15 km **RANGE**
- Up to 120 km/hr **SPEED**
- Low Radar signature
- Simple **OPERATION**
- Quickly **DEPLOYABLE**
- 15 Minute **FLIGHT TIME**
- Weather **RESISTANT**
- **SMALL** Frame

SCIMITAR Speed, Safety & Surprise



50mm wide quick release double secured straps.



Removable head pad.



6 mesh fabric sections with fast lock hollow carbon fiber poles which slide in/out

Micro-stretcher – for rapid deployment in war zones

Adaptable rescue methods

Suitable for :
4-person horizontal lift
6-person horizontal lift with strap
Vertical winch by helicopter/
mechanical means with hoisting strap assembly* (extra)



- Fast assembly below 20 seconds.
- Effective protection & safety: Removable head support & strap.
- 4 restraining straps, groin /over body straps & spinal support for ease of securing the casualty.
- Easy assembly: No training necessary.
- Folds into 6 sections, so easy to stow
- Strong and durable rigid stretcher: Strain tested to transport a load of 311 kilo (equivalent to 47 stone).
- Easy to clean, mesh fabric & frame.
- Back-packable for hands-free carrying.



Survival & Medical Kits

- Innovative and intuitive survival solutions for over 50 years
- For fast jets, rotary wing and transport planes, tanks and armoured vehicles
- Individual or group survival packs
- Supplied to Special Forces, Air Forces and Land Forces
- We have helped save many thousands of lives over the years





Medical Solutions

- Innovative and intuitive medical solutions for over 50 years
- Individual or group packs
- For Air Forces, Land Forces, Maritime, Polar
- Jets, rotary wing & transport planes, armoured vehicles,
- Basic to Platoon Packs
- Vacuum packing
- Medicine Licence



IFAK

- Tough, compact
- Internal pockets
- MOLLE-compatible
- Quick, easy access
- Easy pull zip handles



SPECIALIST
FIRST AID PACKS
Sets & compact versions

specialist
DRESSINGS



Batch : INT22138 D.O.M. 03/2019
 STORE BELOW 25°
 www.bcb.in.com

CONTENTS:

- 1 x Elastoplast 7.5x5cm
- 1 x Safety Pins 6's
- 1 x Dressing No. 8
- 8 x Salt Sachets
- 6 x Antiseptic Wipes
- 2 x Sall Needles 2"
- 1 X Tweezers

Functional, rugged furniture currently in service with the UK MoD

- NATO codified
- Robust
- Lightweight
- Space efficient

Rugged Camp Cot



Disassembly of Camp Cot

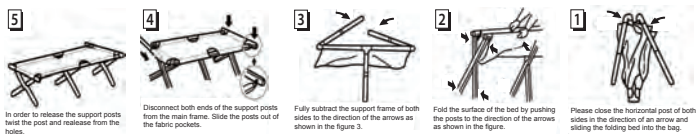

Field Desk:
Transportable
Easily deployed
Privacy Screen
Secure storage

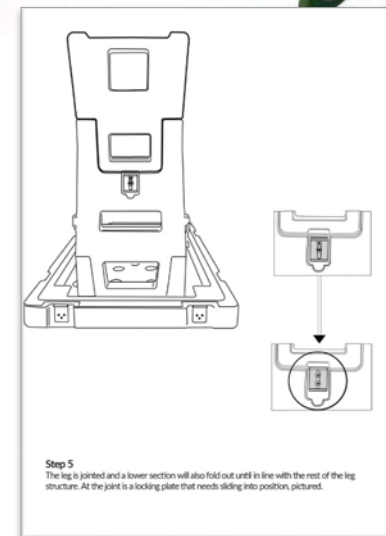
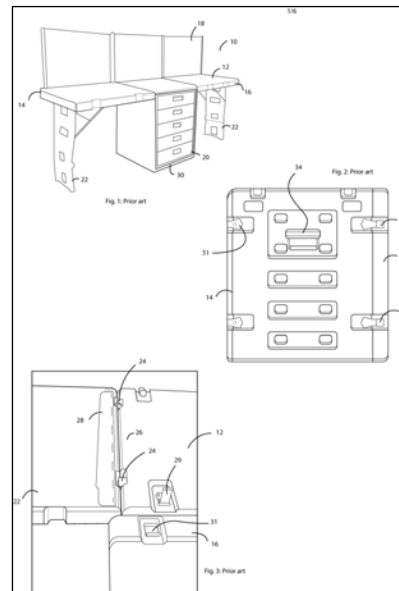



Field Sleeping Systems



Self inflating Sleeping Mat



Modular Sleeping Systems
LIGHTWEIGHT & MEDIUM
WEIGHT



SOFT INNER LINING
FOR COMFORT

HEAD PROTECTED
WITH ZIPPERED
INSECT NETTING

WATERPROOF
OUTER LINING ON
UNDERSIDE



4 Seasons
Sleeping Bag



Mattress

Mosquito
Net on a
camp cot





Boat Stopping System (BSS)

Air powered, powerful launching system

- Non-Lethal
- 100% effective; it doesn't need to snag or entangle the propeller
- Simple to use; just uses compressed air
- Provides a layered defence
- Scalable for large & small boats
- Does not damage or sink the target boat
- Can also be used to deploy survival equipment
- Extensively tested and in service
- Significant and reliable stopping power





Boat Stopping Systems (BSS)

Versatile applications for defence and control of waterways, borders and zones



- Repeat orders from the UK navy.
- The US Navy and maritime Army have conducted extensive trials.
- US Navy purchased for extended trials at the US Naval Surface Warfare Centre.
- Other forces are keen to trial including the UAE navy, Singapore, India, Kuwait, Indonesia, Japan, Malaysia, Spain, Malta, Saudi, Korea, France, Italy and Denmark.
- World patents granted
- More can be seen on video.



Click Play



Marine Polar Range



Specialist Marine and extreme cold weather survival equipment for commercial.
Personal kits • larger group kits.



Both kits comply with the Polar Code (IMO Resolution MSC.385(94)), PART I-B paragraph 9.2



Polar Kits - A new regulation called "The Polar Code" which required all international shipping to carry new extreme cold weather survival packs. BCB was instrumental in helping design the products which have now been extensively adopted by most vessels going into the Polar regions. Due to climate warming the North West passage is now more accessible than ever.



BCB have developed and manufactured polar survival kits in accordance with the new IMO Polar Code. Waterproof durable, robust, float when packed in their bespoke waterproof kit bags. They are specially designed to aid survival in the polar regions. Tested in the extreme of the Polar regions.



Marine offshore health, safety and personal protection equipment is carried for support vessels or each turbine.

Running stock will be maintained at the onshore OMS logistics facilities.

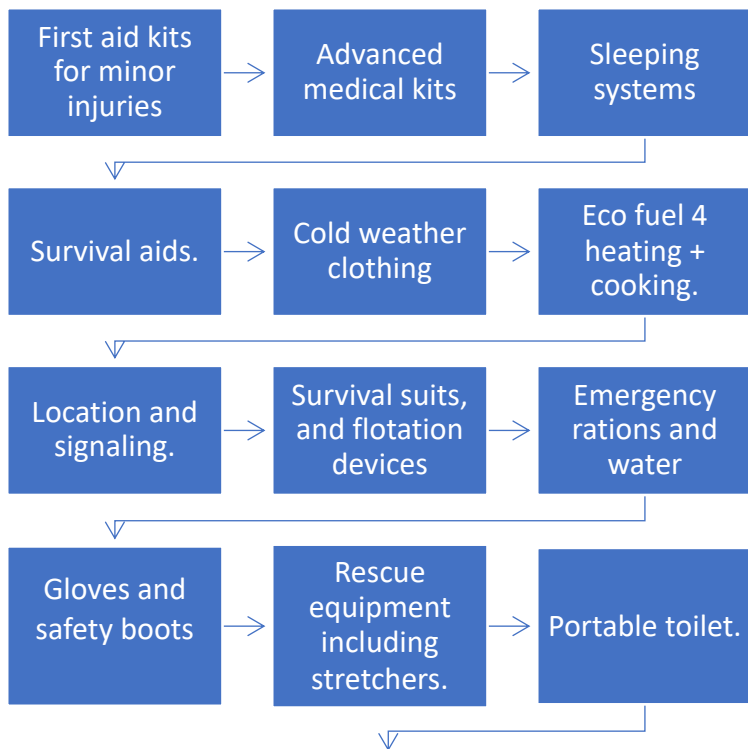

To permit overnight occupation in the turbine in the event of poor weather or support vessel issues.



Growing offshore wind market.



Outdoor Market

Camping, Bushcraft, and fishing products

User friendly B2C eCommerce site, “trade only” section, and Rapid dispatch



Available in over 800 outlets in UK

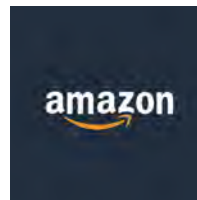

FireDragon Fuel for Ukraine project. (FFU)

FIREDRAGON
High Performance
Eco fuel



BCB, Vinnytsia National Technical University and Golden Box have an opportunity to distribute our clean cooking fuel, FireDragon to Ukraine.

AIM: SOLVE the Ukrainian energy crisis

FIREDRAGON

ATTRIBUTES:



SUSTAINABLE - Made from waste vegetation.



BURNS CLEAN – HUGE REDUCTION

in greenhouse gases (100% less methane than charcoal/firewood).



BURNS SAFELY INDOORS

Perfect for users in apartment blocks in blackout.

COMPATABLE WITH MOST STOVES

perfect for soldiers and the internally displaced.



VERSATILE

Easily lit in all weathers, even when fuel is wet.

STATUS:

- PROJECT FUNDS APPROVED
- Project worth £1,286,999.
- PURPOSE: Ethanol (FireDragon) production
- LONG TERM strategy for FireDragon PRODUCTION & DISTRIBUTION.



BENEFITS:

- **IMPROVE GREEN ENERGY ACCESS**, localising production will bring to market an affordable clean cooking fuel.
- **CREATE LICENSED EMPLOYMENT**, creating an income for desperate families in the war-torn state.

RESEARCH + LOCAL PRODUCTION

=

- Affordable
- Available
- Low cost



TARGET MARKETS:

- Ukrainian households.
- Internally Displaced
- Ukrainian Troops

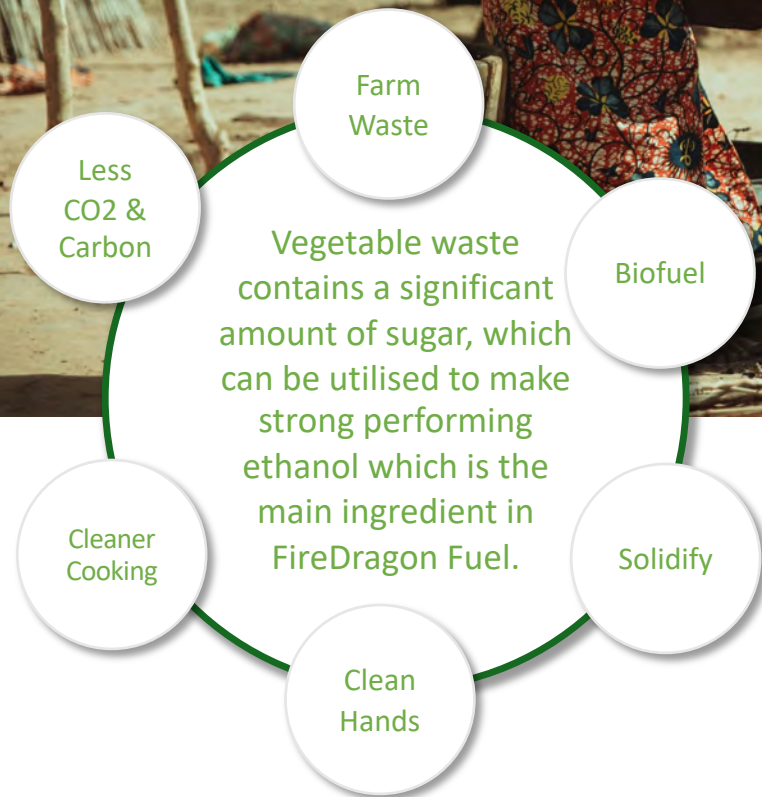

The Sustainable and Affordable Fuel for Energy (SAFE) project.

Solution: to clean cooking for over 4 million people worldwide

FireDragon boasts the following attributes:



Sustainably Produced from waste vegetation.



Burns cleanly, it emits considerably less greenhouse gases than wood or charcoal (**100% less methane compared with charcoal/firewood**).



Is Compatible with popular charcoal and firewood stoves, removing installation costs.

The SAFE project is **sourcing investment** to establish in country liquified and solidified ethanol production.

Localised Production will bring countries the following benefits:

- **Improve green energy access**, localising production will bring to market an affordable clean cooking fuel.
- **Create licensed employment**, creating an alternative to illegal and dangerous charcoal economies.
- **Economize food waste**, liquified ethanol is made from waste vegetation, this will economize a wasted agricultural resource and create an additional income for farmers.





Summary

Expertise in light engineering, medical, camouflaged products and chemical formulations.

Balanced and experienced management team with good financial control and proven production, quality control and distribution structure.

Approx. 550 innovative items. NATO approved. BCB's own design, unique, and IP protected.

Historically, BCB's primary customers have been the UK MoD and manufacturers of life rafts and lifeboats.

Exports 40% to military, security & marine services.

Well established network of sales distributors and direct government long term contracts.

Excellent name and reputation in the 3 diverse, complementary and growing markets.

For over six decades BCB has been at the forefront for some world leading innovations to help save lives and are well known to its customers for the quality of its products.



Three Soldier Technology awards for innovation



Two Queen's Awards for Export Achievement

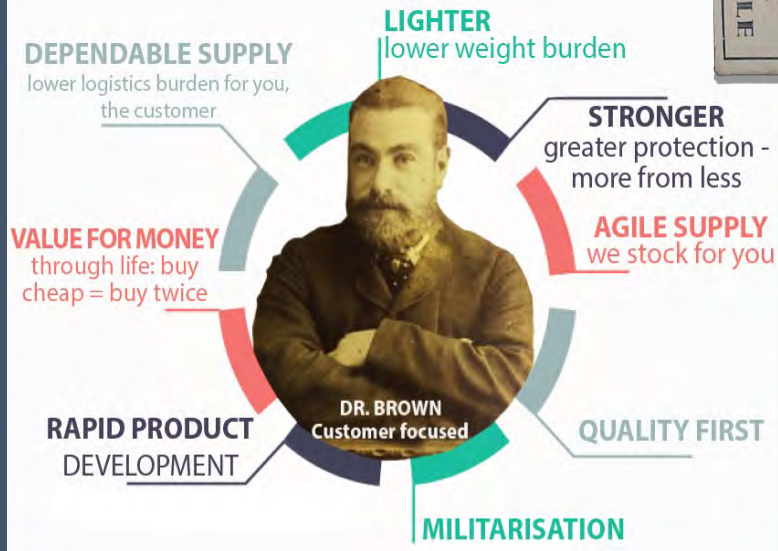



Conclusion

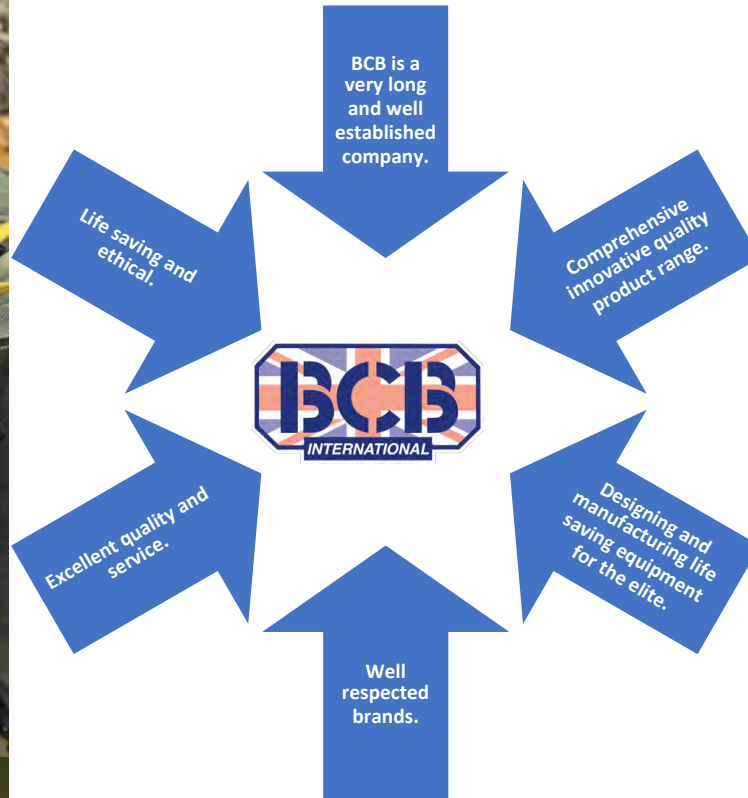

- Considerable investment into R&D and capital equipment.
- Having 3 diverse markets is a great strength, especially in volatile global markets
- Defence and Marine markets provide good long term contracts which underpin revenue streams.
- Product rich, IP protected company.



FIRE DRAGON



“Saving & Protecting Lives in Hostile Environments Through Rapid Innovation”