



Healthcare Products





DR BROWNE'S HAND SANITISER

- Dr Browne's hand sanitiser, one of the strongest on the market, with an 80% alcohol concentration.
- Kills 99.9999% of viruses.
- Used widely by the NHS to provide premium protection.
- Dr Browne's is 50ml and 475ml bottles are now offered with lavender or lemongrass scent, leaving a luscious smell, while fighting to keep you safe. Our 475ml scented sanitiser comes with a pump lid.
- Dr Browne's is approved to* BS EN 14476:2013 + A2:2015, BS EN 1276:2019, BS EN 1500:2013, BS EN 13727:2012 +A2:2015, BS EN 13624:2013.
- Can be used as a surface cleaner.
- Manufactured by BCB in Wales.
- Dr Browne's available in 50ml, 220ml, 475ml and 5 litre

“Sanitisers with lower alcohol content are less effective and according to the CDC, may only slow germ growth, rather than killing it outright.”

N Fischer et al. Institute for Medical Microbiology, Virology and Hygiene. University Medical Centre, Hamburg.

Hand in Hand - Saving Lives.





DR BROWNE'S HAND SANITISER

Why Dr Browne's?

Dr Browne's helps to safeguard against bacteria and viruses at a time where hygiene has never been more important.

The threat is a virus not a bacteria. So we have gone the extra mile and had Dr Browne's tested against viruses. Dr Browne's efficacy is to Log 6 or 99.9999% effective against viruses.

We believe hand sanitisers should be tested against viruses. These bacteria tests, though useful, are not that relevant.

Hence why Dr Browne's is extra strength 80% alcohol.

Dr Browne's can also be used as a surface cleaner, and has hand moisturising benefits with the addition of glycerin. With a 100% recyclable bottle, and no animal testing. White label available for a minimum order quantity of 20,000 bottles per size.

About Dr Browne

In 1854 Dr. Browne invented Browne's Cough Bottle (BCB) for the British troops in the Crimean War. Our innovations today continue to save lives on the new frontline.

Dr Browne's 80% formula reduces the number of viruses by over 1 million times

Potential for reducing the risk of disease transmission				
Product	Notes	Log 10 reduction	Kill rate	Viruses remaining
Control – no treatment	3 ³	0	0	10,000,000,000
50% alcohol	5	1	86.87%	1,313,000,000
Simple Soap	4	1	90%	1,000,000,000
Antibacterial soap	5	2	99%	100,000,000
60% alcohol	5	3	99.9%	10,000,000
80% alcohol Dr Browne's	5	6	99.9999%	10,000

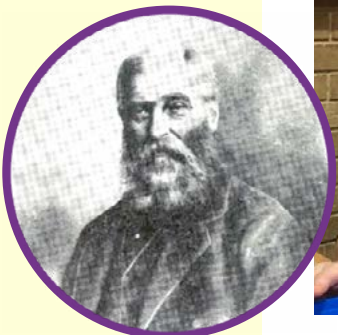

For the full test report against viruses click [here](#)

Hand Sanitiser

Protection Packs

Masks

Other PPE





Dr Browne's Wall Mount

Code: CL920

Our new Dr Browne's Wall mount makes keeping your hands clean even easier. Works perfectly with Dr Browne's hand sanitiser. Easy to install, easy to keep safe.

- Easy to install
- Easy to clean
- Works with Dr Browne's 475ml Pump bottles.
- Comes with screws, wall plugs, caps and covers.



Hand Sanitiser

Protection Packs

Masks

Other PPE





Personal Protection Pack

Code: CK074B

Easy to access belt pouch.
A small pouch with a large capacity to keep you safe in this time of need.
Fitted with a water resistant double zip, two belt loops and a clear internal pocket.

- 50ml Dr. Browne's Hand Sanitiser
 - 10 Sterile Wipes
 - 2 x Type IIR Face Mask
 - 10 Nitrile Gloves (Medium/Large)
 - Information Leaflet
 - First Aid Guide
- Contents may change.



Hand Sanitiser

Protection Packs

Masks

Other PPE





Back 2 Work Kit

Code: CK073A

With many companies returning to work there is a lot of uncertainty about how to stay safe? We want to encourage change by minimising the spread of germs in the work place. This is why we have created packs of high quality products, to keep you safe. Our kit is here to make you feel safe and confident going back to work.

Included:

- 50ml Hand Sanitiser Gel
- Instruction Sheet
- 2 x Nitrile Gloves (Medium/Large)
- 3 x Antiseptic Wipes
- Forehead Thermometer
- Type IIR Mask
- 2 x Coin Towels

For orders over 10,000 pack labels can be personalised

Contents may change.

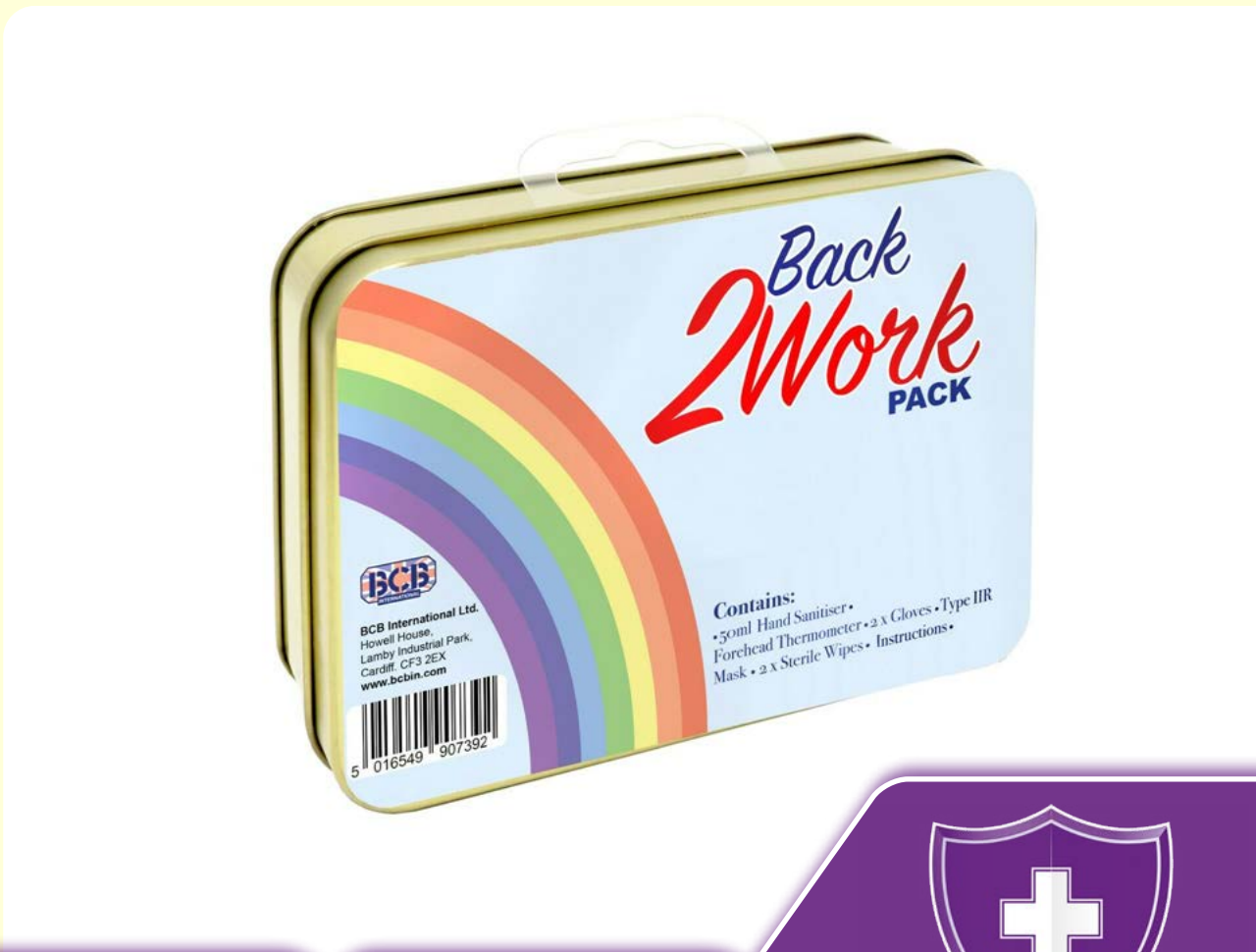

Hand Sanitiser

Protection Packs

Masks

Other PPE





The British Medical Association is appealing for a higher grade of face mask to guard against coronavirus infection.

In Recent BBC News article, David Shukman reports;

A thousand health professionals have backed an appeal for hospital staff to be given improved Personal Protective Equipment.

“In an open letter to UK political leaders, they say there is growing evidence that tiny Coronavirus particles can spread through the air. The group want general ward staff to be given the type of high-quality masks usually only worn in intensive care.”

“More sophisticated masks - a type known as FFP3 that includes an air filter - are only required in intensive care or when certain procedures are carried out that are known to generate aerosols.

In their letter, the consultants, doctors and nurses say healthcare workers are three to four times more likely to become infected than the general population. But they point out that staff in intensive care units, who have the best level of protection, have about half the risk of catching the virus than colleagues on general wards.

The letter states: “it is now essential that healthcare workers have their PPE upgraded to protect against airborne transmission”.”

“FFP3 is the recommended class of respiratory protection for use in the healthcare sector for protection against biological agents, such as pandemic flu.”
- Health and Safety Executive report RR1087



TYPE IIR



FFP2 Mask no Valve



FFP2 Face Mask with Valve



FFP3 Face Mask with Valve

“According to a December 2020 study done by the Proceedings of the National Academy of Sciences, USA, in Germany, face masks have reduced the number of new infections by around 47%. As economic costs are close to zero compared to other public health measures, masks seem to be a cost-effective means to combat COVID-19.”

“Germans will be obliged to wear medical-grade masks in shops and on public transport until Valentine’s Day under tighter lockdown measures announced 19th January 2021.

Cloth masks, which seem to be less effective at blocking the virus, will no longer be regarded as acceptable mouth and nose coverings in enclosed public spaces.

Instead people will be required to use either “OP” surgical masks or those that meet or exceed Europe’s FFP2 standard.”

Hand Sanitiser

Protection Packs

Masks

Other PPE





Type IIR

Code: RK202

Our Type IIR masks are fluid resistant. These medical face masks are intended to be worn to protect against the spread or transmission of infectious germs, as well as protecting against the splashes of liquids and particles. Comes in packs of 50.

- Medical Devices Directive 93-42-EEC
- ISO 13485
- EN 14689 2019
- Standard: EN14683
- Outer layer: polypropylene non-woven fabric, water-repellent effect layer.
- Middle layer: provides a highly protective filter layer, bacterial filtration rate is greater than 98%, and particle filtration rate is greater than 95%.
- Inner layer: polyester soft skin-friendly non-woven fabric.



Hand Sanitiser

Protection Packs

Masks

Other PPE





FFP2 Face Mask

Code: CL290

4 layer structure mask:

1. Non woven waterproof layer
2. Non woven fabric
3. Melt blown fabric
4. Non woven fabric

- Elastic ear loop.
- 95% filtration mask.
- EN 149:2001
- Lightweight, skin friendly fabric.
- Adjustable nose bridge.
- Mask can last up to 7 days depending on use.
 - Heavy Usage – 8 hours
 - Medium Usage – 3 days
 - Light usage – 7 days

If they are not removed/adorned and stored correctly when in use, the user may still become infected.





FFP2 Face Mask with Valve

Code: CL292A

Breathable and hypoallergenic masks with a high efficient filtration, with a valve.

- BFE > 95% filtering capacity of particles with a mass median diameter of 0.3 micrometers
- Conforms to Regulation EU 2016/425
- Protects against anti-haze, dust, bacteria, and viruses
- The nose bar can be molded around the nose bridge for a tight but comfortable fit.
- Advanced non-woven and a melt-blown fabric material
- 4 layers of soft virgin non-woven protection.
- Skin friendly fabric, with loops over the head.
- Lightweight for more comfort

ISO 13485

Conforms to EN 149:2001 + A1:2009
Respiratory protective devices

CE Certified



The 4-Point adjustable straps wrap around head for security and comfort



The exhaled air is vented downward to prevent spectacles misting





FFP3 Face Mask with Valve

Code: CL291

The convex shape, soft inner face-seal ring, 4-point adjustable straps and adjustable nose clip ensure comfortable wear over a range of face sizes. The Valve makes it easier for the user to breath and talk. The inner face-seal has the innovative NI (nose isolation) protection design which provides comfort on nose and create highest standard sealing.



- Comfortable and lightweight 4-point adjustable straps
- Traditional convex shape with nose clip.
- E-Valve design provides cooler and more comfortable wear.
- Inner face-seal ring.
- Reliable and effective protection against fine particles with high performance filter material
- Durable, collapse resistant inner shell
- Nonflammable

Conforms to EN 149:2001 + A1:2009
Respiratory protective devices

In trials these masks provided an excellent fit; better than other FFP3 masks.



The exhaled air is vented downward to prevent spectacles misting

The 4-Point adjustable straps wrap around head for security and comfort





FFP2 Face Mask - Mohawk

New Mohawk FFP2 tri-fold masks for ultimate comfort and ultimate protection.

Features

- Adjustable nose clip
- Soft nose foam
- Adjustable straps
- 3 panel, flat fold style
- Exhalation valve



Material Composition

- Straps – Polyamid/Elastane and Polyester
- Nose Clip – Aluminum
- Nose foam - Polyurethane
- Valve – Polypropylene
- Shell – fiber
- Coverweb - Polypropylene
- Approximate weight of product: 15.10 gr

Shelf Life and Storage

- 3 years from the date of manufacture
- Store respirators in the original packaging, away from contaminated areas, dust, sunlight, extreme temperatures, excessive moisture, and damaging chemicals
- Store in temperatures between -20°C and +40°C and not exceeding 80% RH



Tested to: EN 149:2001+A1:2009

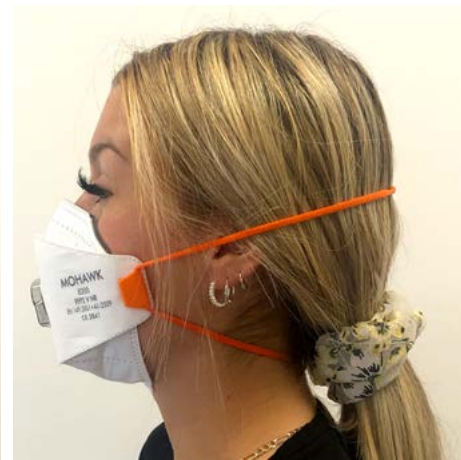



FFP3 Face Mask - Mohawk

New Mohawk FFP3 tri-fold masks for ultimate comfort and ultimate protection.

Features

- Adjustable nose clip
- Soft nose foam
- Adjustable straps
- 3 panel, flat fold style
- Exhalation valve



Material Composition

- Straps – Polyamid/Elastane and Polyester
- Nose Clip – Aluminum
- Nose foam - Polyurethane
- Valve – Polypropylene
- Shell – fiber
- Coverweb - Polypropylene
- Approximate weight of product: 15.10 gr

Shelf Life and Storage

- 3 years from the date of manufacture
- Store respirators in the original packaging, away from contaminated areas, dust, sunlight, extreme temperatures, excessive moisture, and damaging chemicals
- Store in temperatures between -20°C and +40°C and not exceeding 80% RH



Tested to: EN 149:2001+A1:2009





Reusable Forehead Thermometer

Code: RM086

Quick, Simple and Reliable. Lightweight and robust, keep it handy.

A range of Forehead and Anesthesia Temperature Indicators for the healthcare sector.

Liquid Crystal technology for the measurement of clinical temperature trends in the healthcare environment.

These liquid crystal thermometers are reusable and designed for use on the forehead area only and are an ideal way to estimate the core body temperature and check for temperature changes. Robust, quick reading can be used between clinical thermometer readings and to monitor trends. CE Certified.

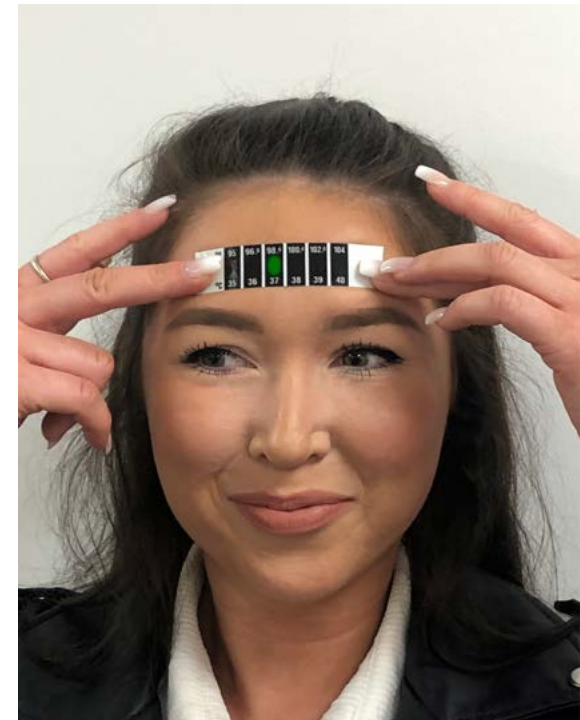
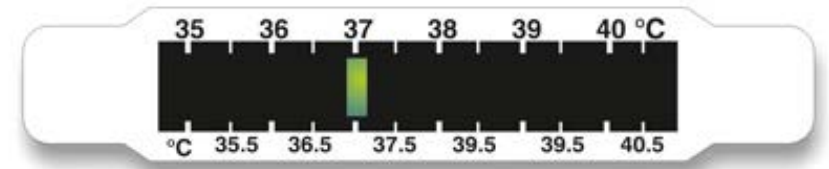

Hand Sanitiser

Protection Packs

Masks

Other PPE





Infrared Thermometer

Code: CL504

This Infrared Thermometers design is simple and elegant. It can measure accurately without contact, making it cleaner and more sanitary. It has very good adaptability to environmental changes and can be used in complex environments. It will also register when the users measurements are 'safe', 'slight fever' and 'high temperature'. It comes with a forehead mode and a ear mode, with different heads for each. The probe cover is magnetic, keeping the probe virus free.

- One Second Fast Measurements
- 40 Memory Recalls
- Audio & Visual Fever Warning
- Mute Function
- BPA & Latex Free
- Celsius and Fahrenheit Measurements



Hand Sanitiser

Protection Packs

Masks

Other PPE





Protective Safety Goggles

Code: CL501

Safety Glasses with clear, Anti-Fog Design.
180 degree wide vision.
Anti-smog, anti-dust, anti-spitting splash.
High impact Resistance perfect.
EU Regulation 2016/425

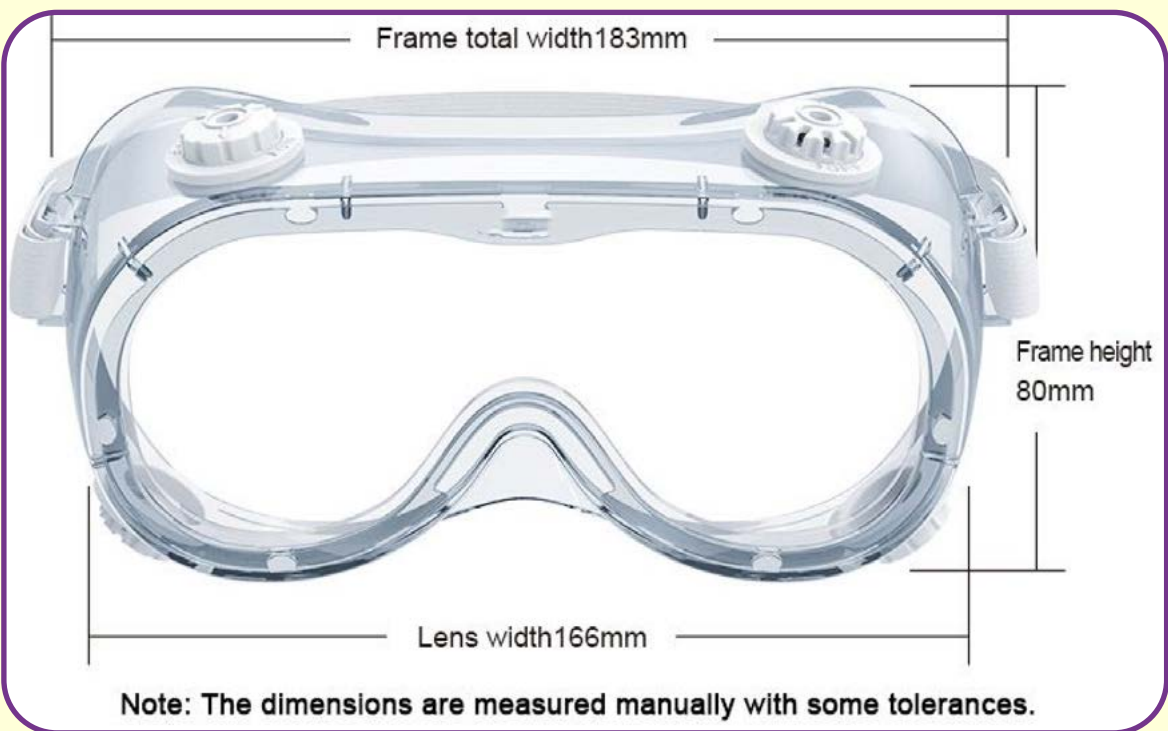

Hand Sanitiser

Protection Packs

Masks

Other PPE





Nitrile Gloves, Box of 100

They have been designed for maximum sensitivity, dexterity and comfort, and offer increased elasticity and flexibility to reduce the risk of fatigue when in use for extended periods of time. These gloves are an essential piece of PPE (Personal Protective Equipment) and allow the wearer to use the gloves at ease and with additional reassurance that they are protected.

Available in X-Small, Small, Medium, Large or X-Large.

CE certified
Powder Free

1 Outer Box can hold 10 boxes of 100 gloves.

EU Regulation 2016/425

Code:	Size:
CL505XS	Extra Small
CL505S	Small
CL505M	Medium
CL505L	Large
CL505XL	Extra Large





Miltipurpose Universal Disinfectant Wipes

Code: CL509

kill at least 99.99% of bacteria and viruses. They can be used for cleaning and disinfecting surfaces, hands and equipment.

Effective from just 10 seconds and can be used on visibly dirty hands. Our formulation is dermatologically tested and contains aloe vera and moisturiser to be gentle on skin. Trusted by healthcare professionals.

Features

- Clean and disinfect in a single step
- Kills at least 99.99% of pathogens
- Resealable plastic lid



Hand Sanitiser

Protection Packs

Masks

Other PPE





Full Face Protective Shield

Code: CL223

Also known as a splash-proof and anti-fog mask/visor. Composed of three parts: a double-sided anti-fog transparent protective sheet, an elastic band and a comfortable forehead foam bank. This helps to prevent airborne infections from above. Provides a clear vision for treatment. EU Regulation 2016/425 as a category III product. In accordance with EN 166:2001

- CE Certified
- Lightweight and easy to wear
- Equipped with an adjustable elastic headband and 25mm thick foam cushion for comfort
- Can be worn with or without glasses or goggles
- PET visor for clearer vision and recyclability

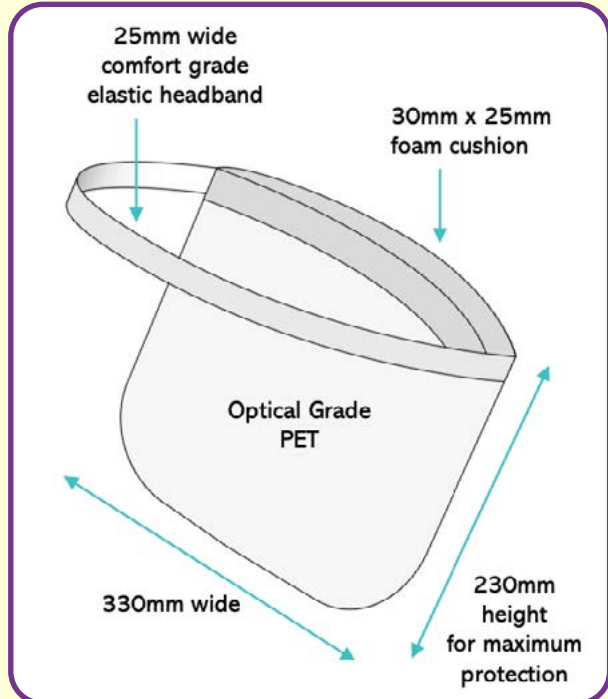



Body Bag

Code: CS624

Specifications:

- Colour: White
- Material: 200 micron - PEVA
- Dimensions: 91x230cm
- Zip: U-shape for ease of access
- dual Pulls, (Interlocking Style)
- Shelf life: 10 years (120 months)

Other information:

- Special reinforced material (2ply) Non-PVC
- Toxic-free
- Tags for toe, outside and personal effects



NO.	Name	_____	Rel.	_____
	Doctor	_____		
	Hospital	_____		
	City	_____	Date	_____
			Expired	_____
	Marking	_____		
ATTACH TO TOE				
NO.	Name	_____	Rel.	_____
	Doctor	_____		
	Hospital	_____		
	City	_____	Date	_____
			Expired	_____
	Marking	_____		
ATTACH TO OUTSIDE				
NO.	Name	_____	Rel.	_____
	Doctor	_____		
	Hospital	_____		
	City	_____	Date	_____
			Expired	_____
	Marking	_____		
ATTACH TO PERSONAL EFFECTS				

Hand Sanitiser

Protection Packs

Masks

Other PPE





For over 160 years, BCB International has built up knowledge and expertise in developing life-saving equipment for the frontline services. Our facility has held a MHRA GDP license for over 30 years, with a heritage of working with the UK government department and military, as well as exporting almost 40% of our products.

Our longstanding and loyal workforce have a wealth of experience in contract manufacturing, supply chain operations, testing and product development. These skills along with our innovation and passion guarantees consistency, quality and safety.

We've devoted our time, resources and investment into applying this knowledge when manufacturing hand sanitiser. We are currently supply to the Welsh and English NHS, British police forces, carehomes and other essential services.

We are here to protect the protectors and save lives.
We won't let you down.



THE QUEEN'S AWARD FOR
EXPORT ACHIEVEMENT



Hand in Hand - Saving Lives.



For the full range please visit:

www.bcb.in.com

To make an order contact:

see@bcb.in.com

02920433700



BCB Hand Sanitiser Production Plant

