

166 Years of lifesaving Innovation



**FIELD
FURNITURE**

BCB HISTORY

1854

Dr Brown invented Brown's Cough Bottle (BCB) for the British troops in the Crimean War.



1900

Brown's Cough Bottle was sold to the public in the UK.



1979

BCB International Ltd was established to develop the military range and export.



1980's

First supply to the United Nations.

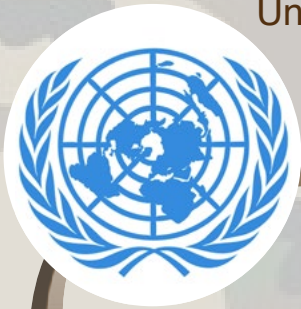

1988

Winner of first Queen Award for Export Achievement.



1985

Pioneer brand of outdoor accessories developed.



1993

LRQA ISO Quality Control approval.



1999

Robotic design begins.



1914

BCB Ltd. was established as a medical company, named after Brown's Cough Bottle.



1940's

First ever medical kit for life boats and rafts were designed and manufactured.



1975

Supply of medical equipment to the first successful expedition to the South West face of Everest.



1967

Developed shark repellent for the U.S. Navy.



1950's

First supply to the British Ministry Of Defence

Brown's Cough Bottle Pastilles are made.



2009

Blast Boxers were designed.



2014

BCB Adventure was set up for the outdoor market.

2007

BCB International Inc. was established in the USA.



2013

FireDragon eco-friendly cooking developed.



TESTED AND APPROVED

Our Field Furniture is tested to the below standards.

BS EN 581-1: 2017 - Domestic. General safety requirements

BS EN 581-2: 2015 - Contract Level.

BS EN 16139 - Level 1 Furniture – Strength, Durability & Safety.

Requirements for Non-domestic Seating (pending)

BS EN 1728-2012 - Based on body mass of 95th percentile male soldier with personal equipment and body armour (+15kg)

BS EN 5438: 1976 Test method - Test method 1 - Minimum ignition time of 20 seconds

BS EN 1021-1: 2014 Part 1 Ignition source smouldering cigarette

BS EN 1021-2: 2014 Part 2 Ignition source match flame equivalent

Environmentally Tested to DEF STAN 00-035



THE QUEEN'S AWARD FOR EXPORT ACHIEVEMENT

“I will find a way, or make one”

(Inveniam viam aut facium)

These words from the great military commander, Hannibal, are a core value here at BCB International Ltd.

Passionate

We are passionate about what we do and will work tirelessly to develop equipment solutions for you who go the extra mile for our security and safety.

Experience

Drawing on our 166 years experience of supporting some of the world’s best military forces, this catalogue contains a selection of high quality innovative products we can offer you.

Survivability

With hundreds of NATO approved products in our range, you can browse this catalogue knowing that our equipment is tested and proven and will not let you down in extreme conditions.

Just ask!

Contact our team and we’ll see what we can do to help. From difficult terrain to extreme weather conditions we’ve worked with military and aid from all over the world for all conditions..

We will endeavour to find a solution for you.

Inveniam viam aut facium!

At your service,

CONTENTS

SITTING/DINING 5-16

CAMPING 17-30

ACCESSORIES 31-36

CAMOFLAGUE 37-40



Field Desks



Deployable Desk² (DD²)

This field desk is simple, **highly practical** and **functional**.

You can add a **removable security screen**.

The DD² is larger and quicker to deploy than the Commander's Field Desk

Robust, lightweight and folds away for storage or transport



Simple and intuitive to deploy (from storage/transportation state) in less than 2 minutes by untrained personnel

Excellent for storing papers, whilst allowing them to be hidden from view for privacy when needed.

Easy and quick to deploy & fold up. Simply unclick, fold out the two flaps & rotate on the central pivot, then fold down the legs.

- A folding privacy screen (available as an optional extra) can quickly & easily be slotted into the front, rear and/or sides to improve secrecy.
- Two plugs or computer extension sockets (not supplied) can be quickly & easily attached under the two side flaps, so they are easily accessible, while out of sight.
- Lightweight: can easily be carried by two people or manoeuvred on its wheels by one person
- Two large drawers for file dividers & files, two lockable smaller drawers
- Supplied with two BCB folding stools inside.
- Strong, lightweight, drop down legs.
- Smooth flat tabletop when opened.

Tested to BS EN 581 & BS EN 15372

Code	FF014 ● FF013 ●
 Kg/oz	45kg (99.2lbs)
	Open: 2125 x 795 x 740mm (83.6 x 31.2 x 29.1") Closed: 675 x 795 x 740mm (26.5 x 31.2 x 29.1")

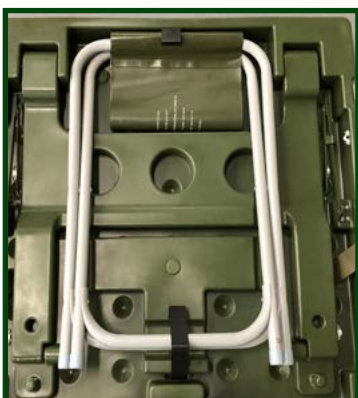



Code	FF003 - Privacy Screen
 Kg/oz	1.6kg (56oz)
 Unfolded:	193 x 45.5 x 1cm (76 x 17.9 x 0.4")

Privacy Screen

PVC coated on both sides

Resistant to fire damage and the spread of flames

Simply attach the privacy screen for a fully-functional, discreet desk.

Fits into a drawstring bag and can be placed into the draw of the Field Desk.

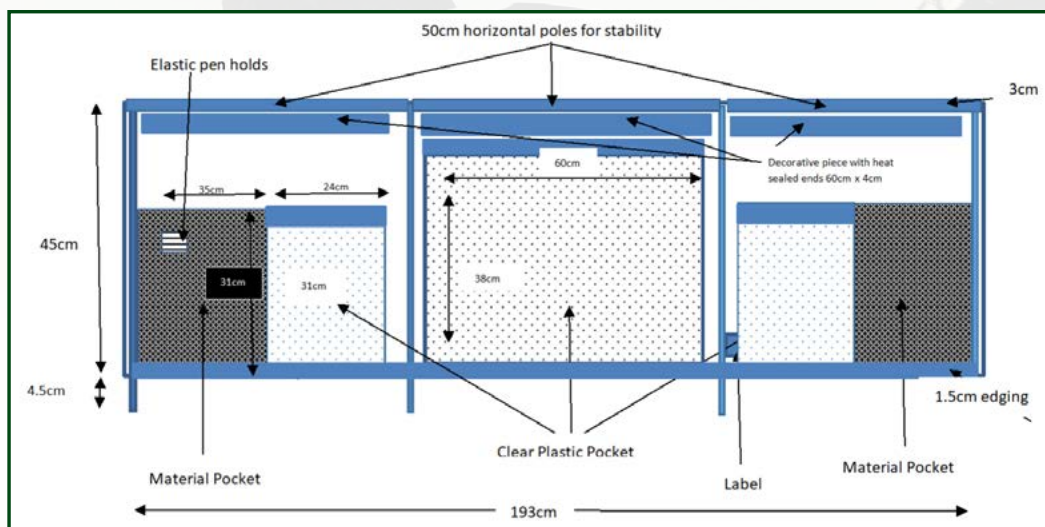

Field Desks



Commander's Field Desk (CFD)

Includes five spacious drawers and large surface area

Foldable design makes transport practical and space-saving. It is then easy to fold open into place





Commander's Field Desk with Wheels

The same classic design as our original Commander's Field Desk (FF002) in use by the British MoD since 2015, raised by four wheels for increase mobility.



Extended supporting legs.

Lockable wheels.



Code	Commanders Field Desk - FF002	With Wheels - FF002A
Nato	NSN 7110-99-555-5662	TBC
	44kg (97lbs)	50kg (110.2lbs)
	Unfolded: 200 x 59 x 73cm (78 x 23 x 28") Folded: 70 x 59 x 73cm (27 x 23 x 28")	Open: 200 x 84 x 56cm (78.7 x 33 x 22") Closed: 72.5 x 84 x 56cm (28.5 x 33 x 22")

Deployable Field Desk

Code	FF013
 Kg/oz	54.5kg
	Folded: 86 x 72.4 x 63 cm Opened: 259 x 72.4 x 72.4 cm

The Field Desk is easy to transport. It is waterproof and impact resistant. It features two desk worktops. It can be folded down into a container equipped with two transport wheels and two grab handles for greater mobility.

Desk comprises:

- Two wide level desk worktops.
- Six drawers: 2 drawers (dimensions: 21x30cm); 2 lockable drawers; 2 large drawers designed for suspension files.
- Two foldable and comfortable field chairs with robust back rests. The chairs can be stowed away in the lids in a matter of seconds.
- Two 6 plugs power leads (230V/16A) equipped with two USB ports for electronic equipment.



Folding Stools

This small lightweight stool is strong and robust

Frame work: 22.3mm diameter, steel

Seated pad pvc:

Wipe clean material

Fire retardant

Olive green

Rubber feet for extra grip



Code	FF004
NATO	NSN- 7105-99-912-2211
Kg/oz	60g (2oz)
	Packed: 41.5 x 5 x 61cm Unpacked: 41.5 x 44 x 44cm



Lightweight, strong and robust

Frame work: 22.3mm diameter, olive finish steel

Seated pad pvc: 45 (l) x 30 (w) x 0.55cm

Wipe clean material

Fire retardant

Olive green

Rubber feet for extra grip

5-year service life, 10-year storage life

Code	FF018
Kg/oz	2.9Kg (6.3lb)
	Folded: 68 x 5 x 30cm (26.7 x 1.9 x 11.8") Unpacked: 68 x 45 x 30cm (26.7 x 17.7 x 11.8")

A variant of the above stool, different in size but just as robust with wipe clean material.

Fire retardant

Olive green

5-year service life, 10-year storage life



Code	FF004B
Kg/oz	60g (2oz)
	Folded: 41.5cm(W)x5cm(D)x61cm(H) Unpacked: 41.5cm(W)x44cm(D)x44cm(H)







Recreational Chair with bag

The Recreational Chair is robust, lightweight and comfortable for use. Capable of supporting 95th percentile male with personal equipment and body armour (+15kg). Simple and intuitive to deploy (from storage/transportation state). The chair is stable and has a maximum drop of 25mm between legs to ensure product remains stable on uneven ground.

Code	FF017
Nato	NSN 7110-99-555-5662
 Kg/oz	5.3kg (11.9lbs) with bag 6.1kg (13.4lbs)
	Packed: 77.5 x 52.5 x 56cm Unpacked: 78.5 x 50.5 x 61.5cm

Folding Chair

Robust, lightweight and space efficient seating system
Will fit comfortably and interoperable with the folding table and field desks
Strong HDPE plastic panel
Powder coating finished steel frame: 28 x 1.0mm
Stackable and can easily carried by one person
Plastic feet for extra grip and stability
Manufactured to ISO 9001/2008

Code	FF009
NATO	NSN- 7105-99-729-8853
 Kg/oz	5kg (11lbs)
	Packed: 17 x 47 x 115cm (6.7 x 18.5 x 45") Unpacked: 52 x 47 x 89cm (20.5 x 18.4 x 35")

Perfect for use with the Field Desk and Table



Folding Chair MKII



Suitable for all terrains. Can be used indoors and outdoors.

- Stackable when folded.
- Foldable
- Anti-sink legs
- Fire resistance: M2.
- Seat and back rests: High Density Polyethylene.
- Anti-UV treated
- Round edges
- Colour : Dark Green
- Metal framework:
- In anti-corrosion steel
- Epoxy finish
- Dark Green

Code	FF009
 Kg/oz	Load Limit: 180kg
	Opened: 180 x 75 x 72cm

General Service Wooden Bench

- Rubber feet
- Strong - holds 4+ people
- Robust, lightweight and space efficient
- Can be used independently and in conjunction with other field furniture as defined in this specification
- Easy to deploy
- Suitable to be carried by one person
- Tested to conform to: BS EN 581, BS EN 16139
- Manufactured to ISO 9001/2008

Code	FF001
NATO	NSN- 7210-99-731-1754
 Kg/oz	6.8kg (14.9lbs)
	Unpacked: (L)220x(W)80x(H)110cm



The bench is comfortable for use for the 5th percentile male as defined by DEF STAN 00-251 and HF Integration Management System (HuFIMS), This product is suitable for use independently or when used in conjunction with the folding table, general service, typically for dining purposes or as audience/briefing seating.





General Service Wooden Table

A strong and durable table with reinforced foldable steel legs. The table consists of a quick release locking system to secure the legs. It is capable of supporting a uniform distributed load of 1.25kN/m² (ie 125lg over a 1 x 1m area) and resisting a point load of 80kN/m² (i.e. 5kg over a 25 x 25 mm area) With a maximum anticapped overall working load of 250kg.

Toughened plastic top.

HDPE plastic panel thickness: 4.0cm
Powder coating finished steel Frame:
28 x 1.00mm

Code	FF012
NATO	NSN-7110-99-555-5662
 Kg/oz	13kg
	Overall size: 184(L)x76(W)x73cm(H) Packing size: 186x77x4.5cm

Tested to conform to: BS EN 581 -1: 2017
BS EN 581 - 3:2017
BS EN 15372: 2016 Level 2
Environmentally tested based on DEF STAN 00 - 035

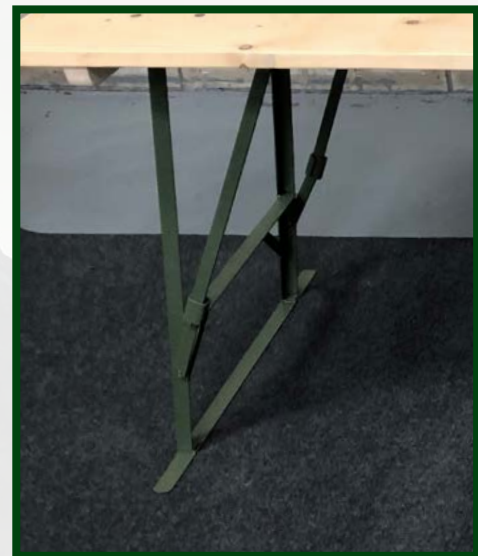
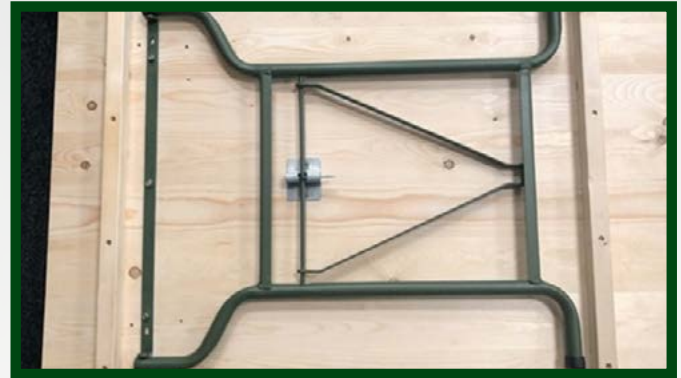

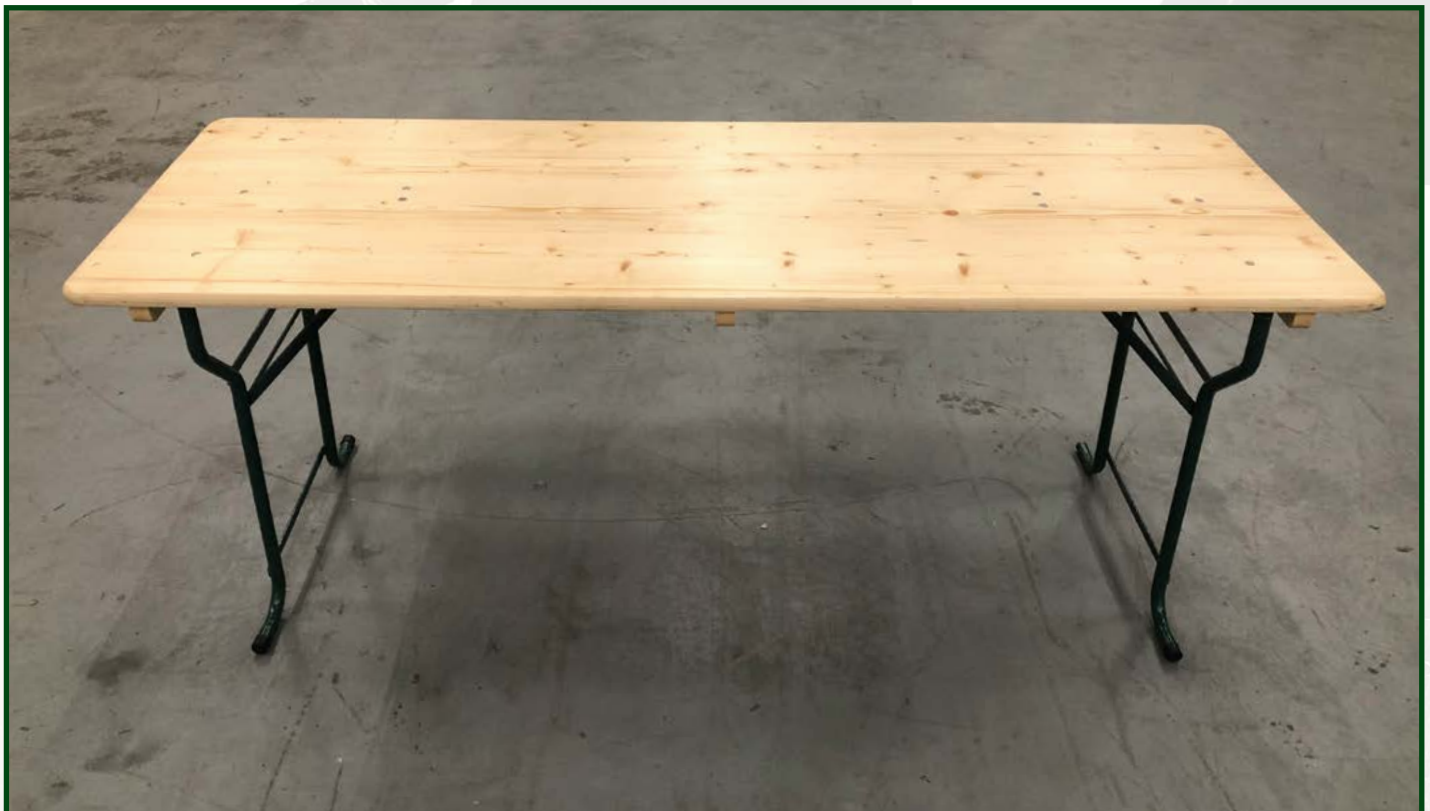

Both bench and table are available with alternative legs for softer ground



General Service Bench

- Rubber feet
- Strong - holds 4+ people
- Robust, lightweight and space efficient
- Can be used independently and in conjunction with other field furniture as defined in this specification
- Easy to deploy
- Suitable to be carried by one person
- Tested to conform to: BS EN 581, BS EN 16139
- Manufactured to ISO 9001/2008



Code	FF001
NATO	NSN- 7210-99-731-1754
 Kg/oz	6.8kg (14.9lbs)
	Unpacked: (L)220x(W)80x(H)110cm

The bench is comfortable for use for the 5th percentile male as defined by DEF STAN 00-251 and HF Integration Management System (HuFIMS), This product is suitable for use independently or when used in conjunction with the folding table, general service, typically for dining purposes or as audience/briefing seating.

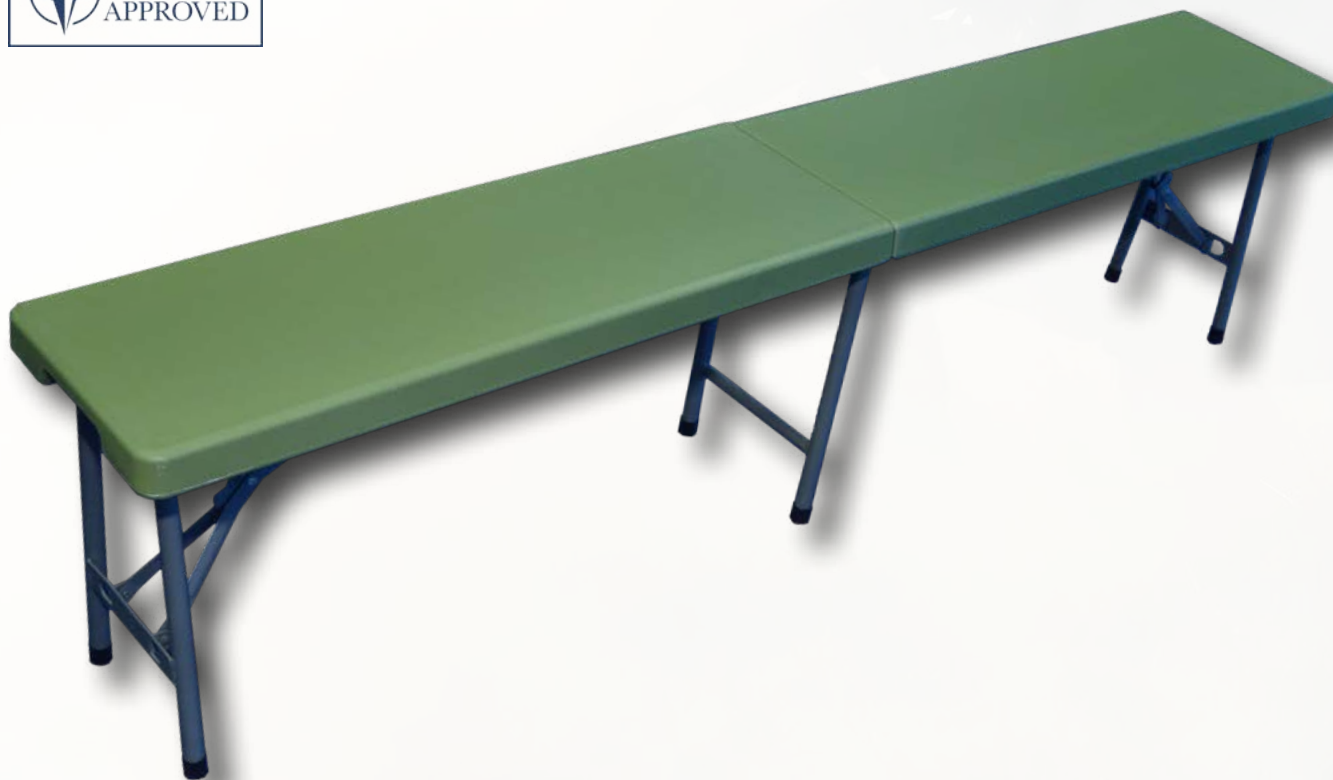

General Service Table

A strong and durable table with reinforced foldable steel legs. The table consists of a quick release locking system to secure the legs. It is capable of supporting a uniform distributed load of 1.25kN/m² (ie 125kg over a 1 x 1m area) and resisting a point load of 80kN/m² (i.e. 5kg over a 25 x 25 mm area) With a maximum anticapped overall working load of 250kg.

Toughened plastic top.

HDPE plastic panel thickness: 4.0cm
Powder coating finished steel Frame:
28 x 1.00mm

Tested to conform to: BS EN 581 -1: 2017
BS EN 581 - 3:2017
BS EN 15372: 2016 Level 2
Environmentally tested based on DEF STAN 00 - 035



General Service Table MKII

Both tables follow the below guidelines:
Tables are all terrain use.
Can be used indoors and outdoors.
Can be stacked when folded.



Worktop:

- One piece in high density polyethylene.
- Anti-UV treated.
- Rounded Edges.
- Colour: NATO Green: sample was white, but will be supplied in Green.

Legs:

- Side folding legs.
- Anti-sink.
- Anti-corrosion treated legs with support frame underneath the worktop.
- Means of securing the the leg in position when opened and closed.
- Paint finish: epoxy finish.
- Colour: dark grey.



Code	FF012
NATO	NSN-7110-99-555-5662
 Kg/oz	13kg
	Overall size: 184(L) x 76(W) x 73cm(H) Packing size: 186 x 77 x 4.5cm

Code	FF012B
NATO	NSN-7110-99-555-5662
 Kg/oz	13kg
	Overall size: 184(L) x 76(W) x 73cm(H) Packing size: 186 x 77 x 4.5cm

Inflatable Tent

The inflatable tent allows four individuals to rest and sleep in adequate comfort to recuperate when on operational deployment.

- Its assembly and breakdown are quick and easy.
- The inside of the tent is divided in two areas:
- One living and storage area.
- One sleeping area.
- The tent also provides protection against mosquitoes thanks to its insecticide treated mosi nets which cover all openings and vents.
- The inflatable tent is supplied with :
 - 20 x ground pegs
 - 1 x mallet
 - 1 x double hand pump with relief valve.
 - 1 x repair kit.
 - 1 x transport bag.
 - User instructions.

Tent (exterior)

- Inflatable parts made out of TPU
- Double skinned light resistant roof made out of polyester.
- Ground sheet inPE 140 g/m², black colour.
- The double skinned roof, walls and ground sheet are waterproof.
- Side door is light resistant and is equipped with a zipped mosi net. The side door can be used independently of the mosi net as an awning thanks to supplied poles (185cm).



 18.3kg
 480 x 275 x 205cm

Four Seasons Tent - 6 Person

Built for the polar regions, the Eira 6000 is the perfect shelter that protects you from all elements, from heavy snow to extreme winds.

The Eira 6000 provides top performance when it comes to wind resistance, thanks to its geodesic shape. The tent remains grounded at simulated wind speeds of 80km/h.

The material is highly water resistant and has a 5000MM Hydrostatic Head Rating. The tent has been designed to be breathable, built with two small air vents which can be easily open or closed via a drawstring.

There are 2 large windows which can be used for light, lookout or extra ventilation.

• 4 Aluminium poles with equal lengths, erecting this tent is simple and straightforward with a pitch time of 5 minutes.

• For added stability and to aid wind resistance, the 60cm Valance, (Snow Skirt) which is featured on the full circumference of the tent can to be weighted with snow or sand.

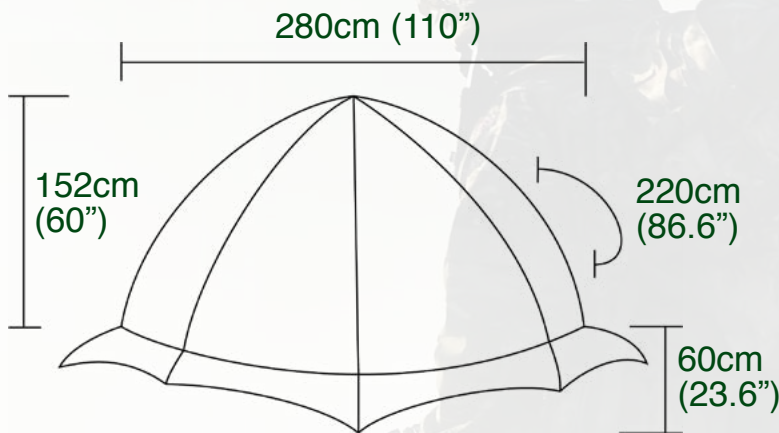

Code	CT670G
Kg/oz	7.5kg (16.5lbs)
	Packed: 68x27x23cm (26x10x9") Open: 280(W) x 220(D) x 152cm(H) (110" x 86.6" x 60")

Ventilation holes



The four pole construction makes it **stable in high winds** and easy to pitch on uneven terrain.

20 pegs included

4 strong aluminium poles for easy set up

Wide strong snow skirt

CAMPING

Four Seasons Tent - 2 Person



all weather, waterproof and lightweight 2 person tent. Designed to handle any wilderness destination you can imagine.



The Four Seasons 2 Person tent provides top performance when it comes to wind resistance, thanks to its geodesic* shape. The tent remains grounded at simulated wind speeds. For added stability and to aid wind resistance, the 20cm Valance, (Snow Skirt) which is featured on the full circumference of the tent can to be weighted with snow or sand.

Contents:

- 3 x Poles
- 18 pegs
- Tent including 20cm valance + guy lines attached
- 9 Guy Lines
- Tent Storage Bag
- Peg Storage Bag
- Pole Storage Bag

 Kg/oz	2.2Kg
	294 (w) x 144 (d) x 124 (h)cm
	53 x 16cm (Packed dimensions)



Four Seasons Tent - 1 Person



all weather, waterproof and lightweight 1 person tent. Designed to handle any wilderness destination you can imagine.



The Four Seasons 1 Person tent provides top performance when it comes to wind resistance, thanks to its geodesic* shape. The tent remains grounded at simulated wind speeds. For added stability and to aid wind resistance, the 20cm Valance, (Snow Skirt) which is featured on the full circumference of the tent can to be weighted with snow or sand.

Contents:

- 3 x Poles
- 20 pegs
- Tent including 20cm valance + guy lines attached
- 3 Guy Lines
- Tent Storage Bag
- Peg Storage Bag
- Pole Storage Bag

 Kg/oz	2.35kg
	235 (w) x 165 (d) x 80 (h)cm
	15 x 15cm (Packed dimensions)



The Four Season Range;

Both the 1 and 2 person connect seamlessly to the larger 6 person tent using one of the vestibules

All three designs are also available in florescent orange for Arctic/Polar Survival.

*Fully Geodesic - The Four Season Range is fully Geodesic.

The fully geodesic design is the perfect partner for the unpredictable and sometimes harsh weather, high level enthusiasts and extreme campers swear by this design of tent. Utilising a minimum of 4 crossover points. The geodesic design ensures its stability in the harshest weather conditions. Able to cope with high winds and snow loads with ease. The fully geodesic structure provides an incredibly stable shelter to spend the night in.

Camp Bed Lightweight

Current NATO issue bed

Strong and robust

Military approved and tested

Compatible with camp-cot mosquito net



Easy and quick to deploy

Cover 500D polyester material

Compact when folded

Manufactured to ISO 9001/2008

Tested to conform to: EN 581-1: 2006,
EN 581-2: 2009

Code	FF006
NATO	NSN- 7105-99-669-8141
 Weight	7.5kg (16.5 lbs)
 Dimensions	Folded: 97cm(L)x18cm(W)x20cm(H) Unpacked:196cm(L)x76cm(W)x44cm(H)



X-Large Folding Bed



Over
2 metres
long



Extra strong **specially designed for large people**. The fabric is treated so that it won't stick or melt in hot temperatures, or make any noise when in use.

Stable on moderately uneven ground

Fabric: 100% **fire resistant** polyester

Frame: **Aluminium**, anti-oxidation



Frame thickness 1.4mm

Thickness 2.5mm

Weight bearing capacity 150KG

Carry bag material 600D polyester

Tested to conform to: EN 581-1: 2006, EN 581-2: 2009

Code	FF006NL
NATO	NSN- 7105-99-669-8141
 Weight	8.5kg (18.7 lbs)
 Dimensions	208 x 68 x 45cm

Folding Camp Cot Bed



The camp cot has been sustainably reinforced to meet the new specification OI/MDA/FF/008. The cot can also be used as a seating area for three persons.

- Resistant to fire damage and the spread of flames.
- Water repellent finish
- Supplied with a carrier bag
- Environmentally tested using DEF STAN 00-035
- Adjustable end bars that can tighten the canvas.

Tested and passed to:



BS EN 581 Pt 1 & 2

BS 5438:1976

BS EN 1021-1:2014 Part 1 & 2

BS EN ISO 13937 - 3:2000





Code	FF022
	9kg (19.8 lbs)
	Packed: 106(L) x 18(W) x 26cm(H) Unpacked: 210(L) x 75(W) x 47.5cm(H)

Folding Mattress

- Lightweight and space efficient.
- Capable of resisting excessive absorption of liquids.
- Comfortable when used in all climatic conditions
- PU cover
- Ease of packing with 7 folding sections (including pillow)
- Hygienic and washable



Manufactured to ISO 9001/2008
 Conforms to: BS7177:2008 + A1 2011
 domestic use, BS EN 597-1: 1995
 Resistance to ignition with source

Code	FF007
NATO	NSN-7210-99-695-4361
	3.2kg (7.05 lbs)
	Packed: 64(L) x 33(W) x 31.5cm(H) Unpacked: 200(L) x 64(W) x 50cm(H)



CAMPING

Shelter Sheet



5 strong ridge eyelets

Waterproof taped seams

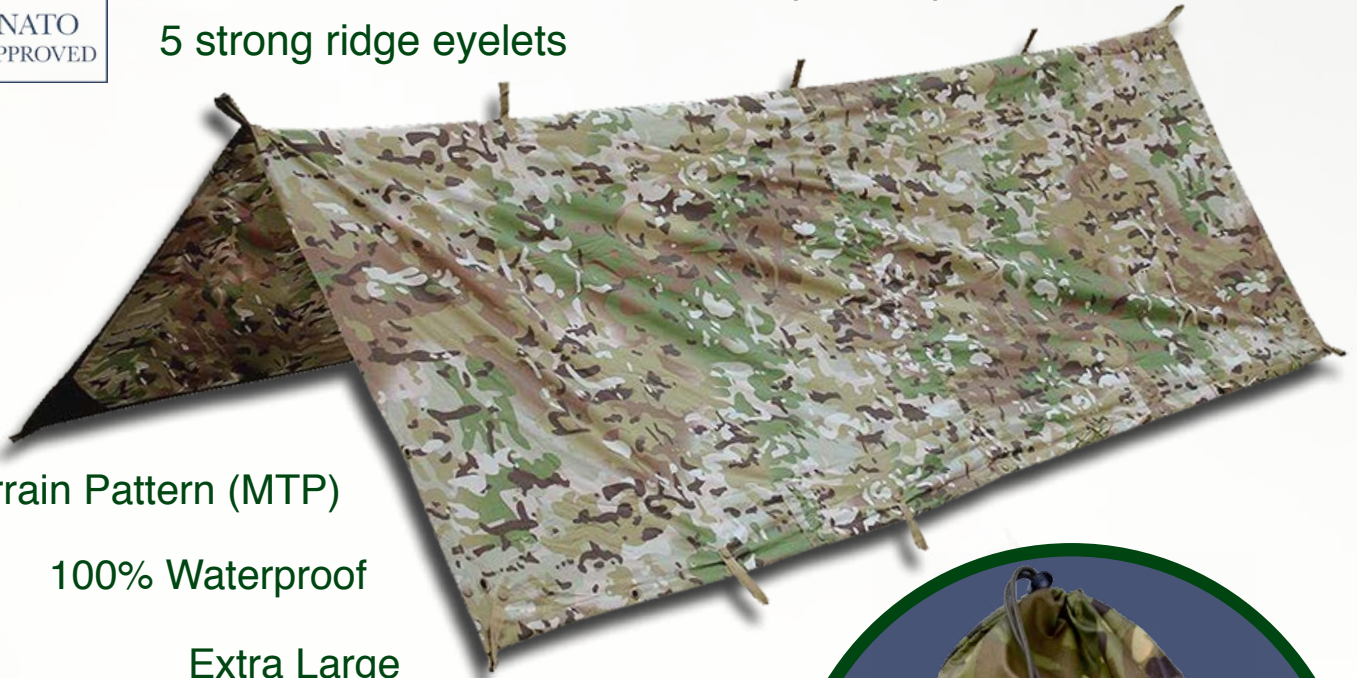

Multi Terrain Pattern (MTP)

100% Waterproof

Extra Large

10 edge eyelets

Can be slung between trees, tethered to vehicles, supported on bivouac poles, or folded double for use as a stretcher.

Comes with a draw-cord closing system made of raided nylon, 9mm wide in light olive green.

Main material is silicone elastomer coated nylon.

Webbings are made of textile, nylon, single ply and the are 25mm & 55mm with a multi-terrain pattern. All ends are heat sealed.





Code	CT125
NATO	NSN 8105-99-213-3731
	2.6 metres x 2.16 metres (8.5 ft x 7 ft)

Steel Pegs





10 Steel pegs for use with tents and bashas

Code	CT017
NATO	NSN 8415-99-213-3730
 Kg/oz	260 grams (9.5oz)
	18cm (7")

Fox® lightweight waterproof 3 part sleeping system

1 cover (basha)

A lightweight robust shelter sheet forming the third element of the fox sleeping system. Features a fully tape-seamed hem and reinforced, suspension points.

Code	CT047 ● CT047G ●
 Kg/oz	630 grams (22.2oz)
	257 x 214cm



- Compact and lightweight
- PU coated Ripstop Nylon
- Woodland camo print
- 16 x suspension points
- NATO approved
- 2 mosquito net suspension points

2 mosquito net



Fox® Jungle Mosquito Net

A rugged, close weave polyester mosquito net.

The net is clipped to fabric loops underneath the basha and via elasticated hooks underneath the hammock.





This shapes the net, pulling the mesh walls away from the body and prevents the net from sagging and allowing insects to enter.

Code	CT433 ●
 Kg/oz	480 grams (16.9oz)
	225 x 120 x 105*cm (88 x 47 x 41*")

3 Hammock

Fox® Jungle Hammock

A generously sized, parachute grade, ripstop-nylon hammock.

Code	CT430 ●
 Kg/oz	590 grams (20.8oz)
	270 x 140*cm (106 x 55*")



Extremely hard wearing and comfortable it provides protection against the elements and biting insects.

Extremely strong.

*Measurements are approximate

Complete Fox System 3 in 1:

The complete system includes hammock, mosquito net & cover (basha)

Code	CT434
	1.7kg (60oz)

Self-Inflating Mat



Extra thick foam makes it ideal for use on stoney terrain.
Brass inflation valve. If required the mat's inflation can be topped up orally via the valve

Fastening straps supplied

Quick & easy to assemble

Top: pvc with a non slip taffeta coating



Base: pvc with a non-slip polyester coating

Load limit: 200kg maximum stuff bag

Top colour: dark green

Base colour: grey

Foam: polyurethane 24kg/m3

Code	CT650D
 Kg/oz	1.39kg (3.06lb)
	Packed: 32 (H) x 19cm (W) Open: 190 (L) x 60 (W) x 2.5cm (H)



Inflatable Airbed

Mummy shaped

Materials (top): 210t diamond ripstop polyester coated pvc orange

Materials (base): doobby polyester coating pvc + foam



Code	CT649
 Kg/oz	770 grams
	Inflated: 180x50x3CM (70.8x19.6x1.1") Packed: 16x26CM (6.2x10.2")

Folding Sleep Mat

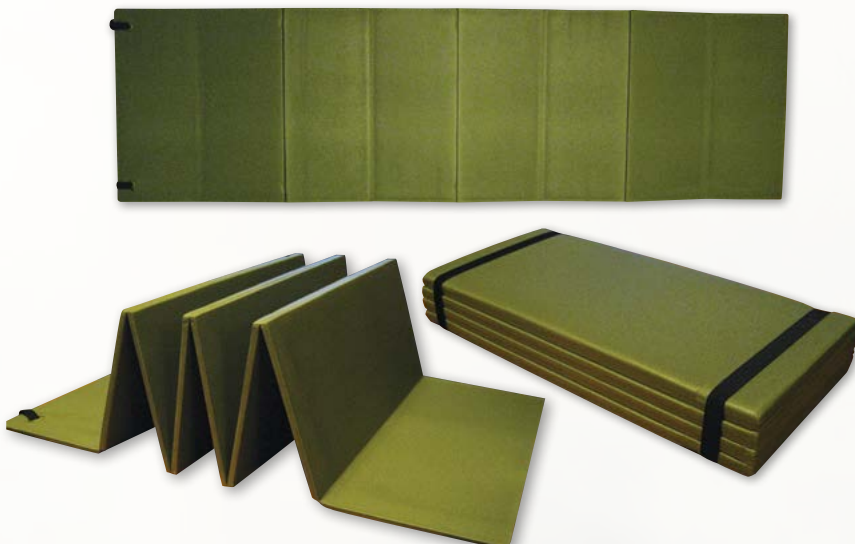



This new foldable sleeping mat **fits inside your rucksack.**

Combines **durability** and **non absorbent** qualities as well as **insulation** and **compression resistant.**

Can be used as a **sit mat** when folded. It can be used fully unfolded or in a **number of combinations.**

Material complies with **UK military standard**



Code	CT650B
 Kg/oz	350 grams
	Open: 52x180x0.8cm (20.5x70.9x0.3") Folded: 52x6x23cm (20.5x2.4x9")

Modular Sleeping Bag System





The modular sleeping system includes **two sleeping bags**:
 One for warmer climates (+12°C)
 One for temperate climates (-2°C - 6°C)

For cold weather, the two sleeping bags can be combined for additional warmth for a temperature range of -6°C and -13°C.

Code	CT128
 Kg/oz	3.2kg (7lbs)
	80 x 220cm (31.5 x 86")



Olif Range Sleeping Bag

Code	Olif SZ: CT1210 Olif 35: CT1200
 Kg/oz	2.4kg
	220cm x 75cm

The Olif is a top of the range sleeping bag designed to withstand extreme climates.

Ranging from -14°C to -35°C, the Olif is a must have to ensure adequate protection against the outdoors.

Both variants are also available in a bright orange colour.

	Olif Sub-Zero	Olif -35
Colour	Olive or Orange	Olive or Orange
Filling	300g/m ² synthetic micro-fibre	400g/m ² synthetic micro-fibre
Shape	Mummy shape with hood	Mummy shape with hood
Outer	70D Ripstop nylon	70D Ripstop nylon
Lining	40D Nylon	40D Nylon
Tested to:	EN ISO 23537-1:2016	EN ISO 23537-1:2016
Extreme	-24°C	-35°C
Low	-7°C	-14°C
Comfort	0°C	-7°C

CAMPING

Camp Cot Mosquito Net

Net top can **hang a torch, book storage bag** and other **personal items**

2 x long 9 section **elasticated strong poles** manufactured to ISO 9001/2008

75D nylon fabric, 21g/m 156 hole/inch

A **compact robust close weave polyester mosquito net**

Easy and quiet open **double zips**

Supported by two aluminium poles, which create a dome effect to ensure the mesh is pulled away from the body and **prevents the net from sagging**

Products material all match WHO standard

Permethrin impregnated

Easy setup - about 8 minutes

Fixes onto **camp cot folding bed**

Noiseless material

Waterproof ground sheet

Two door (side entry)



Code	FF008
NATO	NSN-7210-99-731-1754
	220cm (L) x 80cm (W) x 110cm (H) (86.6 x 31.5 x 43.3")



This mosquito net can be used in conjunction with our camp cot beds or as a stand alone item. The domed design give more head space for easier movement.



Mini Hammock

This lightweight and compact yet durable string-net design mini hammock is ideal for use as typical hammock or as gear storage above wet, dirty or uneven ground. Perfect for camping, backpacking and general leisure.

- **Extremely strong**
- 2.5cm (1") mesh
- Includes **2m (6ft) rope**
- **Lightweight**
- **Holds up to 120kg**

Code	CT430C
 Kg/oz	320 grams (11oz)
	270cm (106")



CAMPING

Solar Shower 20 Litre



A robust, lightweight and easy to use solar shower that holds 20 litres of water.

Includes a temperature gauge, 1 metre long hose, reinforced handle and front pocket.

Easy to maintain and store due to its compact design.

Crease resistant waterproof material, in olive or dark green.



Code	CT1267
 Kg/oz	460 grams (16.2oz)
	33 x 12 x 60cm (13 x 4.7 x 23.6")

Individual Shelter Shower/WC





A sheltered wc or shower with pockets and a door.

It is quick to mount, and easy to clean and maintain.

Robust, compact and lightweight design.

Waterproof (HH1500) and fire resistant (EN-5912)



Crease and pinch resistant

Code	CT126
 Kg/oz	3.3kg (7.3lbs)
	Unfolded: 1.3 x 1.3 x 2.1 metres (51 x 51 x 82") Folded: 55x13x12cm (21 x 5.1 x 0.8")

Hanging Collapsible Wardrobe

The collapsible wardrobe is used by tri-service field force units as a lightweight and space efficient (when stored) personal administration and storage aid within tented accommodation.

- **Simple and intuitive to deploy** (from storage/transportation state) in less than two minutes by untrained personnel.
- Capable of being threaded onto the tent frame when deconstructed, and retro fitted to the constructed tent frame. The ITC tent pole is 2.00 inches in diameter.
- Capable of allowing simple field repairs to be made.
- **Robust**
- Material is resistant to fire damage and the spread of flames
- Distributed load: **20kg**
- Hands from your tent pole.

Code	FF005
NATO	NSN-7105-99-495-1124
 Kg/oz	4.9kg (10.8lbs)
	Packed: 30x30x15cm (11.8x11.8x5.9") Unpacked: 30x30x120cm (11.8x11.8x47.2")



Modular Sun Shade

The sun shade is reversible: Sand colour on one side and NATO Green on the other.



The sun shade is made up of :

- 1 x polyester mesh net with PVC coating
- 6 x suspension/tensioner cords
- 1 x user manual
- 1 x transport bag

Technical Standards

- Fabric: 100% 1100 dtex
- 320 g/m²
- Tear resistance – warp 250N, weft 200N
- Perforation: > 1500N
- Light transmittance: <0.1%
- Temperature range: -30°C/+70°C
- Light resistance: 7-8 (ISO 105 B02 (1998))
- Fire resistance: M2



Code	ff025
 Kg/oz	10.9kg (24lbs)
	Opened: 350 x 60cm (137.8 x 23.6")

CAMPING

Field Wardrobe

This wardrobe is made up of:

- 1 x frame with 4 adjustable feet
- 1 x cover with 8 shelves
- 1 x rail for hanging clothing including body armour (up to 30kg).
- 2 x external D rings for hanging heavy belongings
- Supplied with 8 steel hangers.
- 2 x organisation bellow pockets with transparent bases.
- 1 x pocket with mesh material for dirty laundry.
- 1 x transport bag with grab handle.
- Front face is equipped with two vertical zips
- 2 x mesh ventilation windows at the rear.
- Assembly instructions supplied with wardrobe
- Cover made from PVC coated polyester
- Fire resistance: M1
- Colour: NATO Green
- Wardrobe frame compliant with ISO 9227 (168 hours of salt spray exposure)



100 x 50 x 160cm



Field Clothing Rail

The clothing rail can be fully dismantled to facilitate transportation and storage. The various parts slot into each other and allow for a clothes rail or a drying rack. It is made of the following parts:

- 2 x leg rests
- 2 x upright poles
- 3 x support bars

The metal parts are resistant to a salt spray exposure of 96 hours (ISO 9227).

Colour: Dark Green

Integrated carry straps



Code	FF026
------	-------



ACCESSORIES

Cooler

This cooler has an excellent refrigeration and freezing power.

Extremely efficient and silent

Digital temperature display

Easy to transport: Carrying handle

Solar power running • WIFI application LED lighting • USB port



Storage volume: 46 Litres

Freezing functioning up to -22°C

Power supply: 220V AC/ On battery: 12/24V

Colour: Grey



Code	CA209
	46 litres (80.9 pints)
	20.4kg (45lbs)
	72.5x47x45.5cm

Mess Tins

Made from stainless steel

Finish: Brushed metal on the outside, non-stick on the inside tin and lid.

Smooth finish on the edges and trims

Food safe.

	19.2 x 14.2 x 6.8cm
--	---------------------





Inflatable Pillow



This handy travel pillow packs up **small and is quick to inflate.**

Made of PVC covered with **comfortable Swedish polyester.**



The bottom is **anti-slip** polyester.

Code	CB601
 60 grams (2.1oz)	
 32x22x10cm	

Foam Roll Mat





- Waterproof, rot proof, lightweight, good thermal properties.
- Supplied in stuff sack
- Mat made from polyethylene foam (density of 30kg/m³)
- Elasticated compression straps supplied
- NATO Green or Dark Green colour

 Density: 30 kg/m ³	
 Opened 210 x 74 x 1cm	



Food Tray Container



Code	CB601
 Kg/oz	16.5kg
	External: 44 x 66.5 x 65cm Internal 33 x 53.3 x 51.5cm

Easy to clean and sanitise.

The container is used to transport stainless steel food trays with airtight lids.

The container's materials are compliant with the following standards:

- Regulation CE N°1935/2004
- Regulation CE N°2023/2006
- Regulation CE N° 2016/1416
- Regulation CE N° 852/2004 –HACCP
- EN12571 (thermal categories A,B et C)
- AFNOR AC D40-007

- Operational temperature range: 30°C + 100°C.
- Equipped with transport handles.
- Stackable
- Colour: Army green
- Capacity: 90 Litres

The container can store the following food tray configurations:

- 2 x GN1/1 food trays (each 200 mm in height and equipped with and air tight lid).
- 3 x GN1/1 food trays (each 150 mm in height and equipped with air tight lids)
- 4 x GN1/1 food trays (each 100 mm in height and equipped with air tight lids).
- 6 x GN1/1 food trays (each 65 mm in height and equipped with air tight lids).

Construction

- Internal and external walls in polyethylene.
- Insulation in polyurethane.
- Hinges/clasps in reinforced polyamide fibre-glass.
- Transport handles in stainless steel.

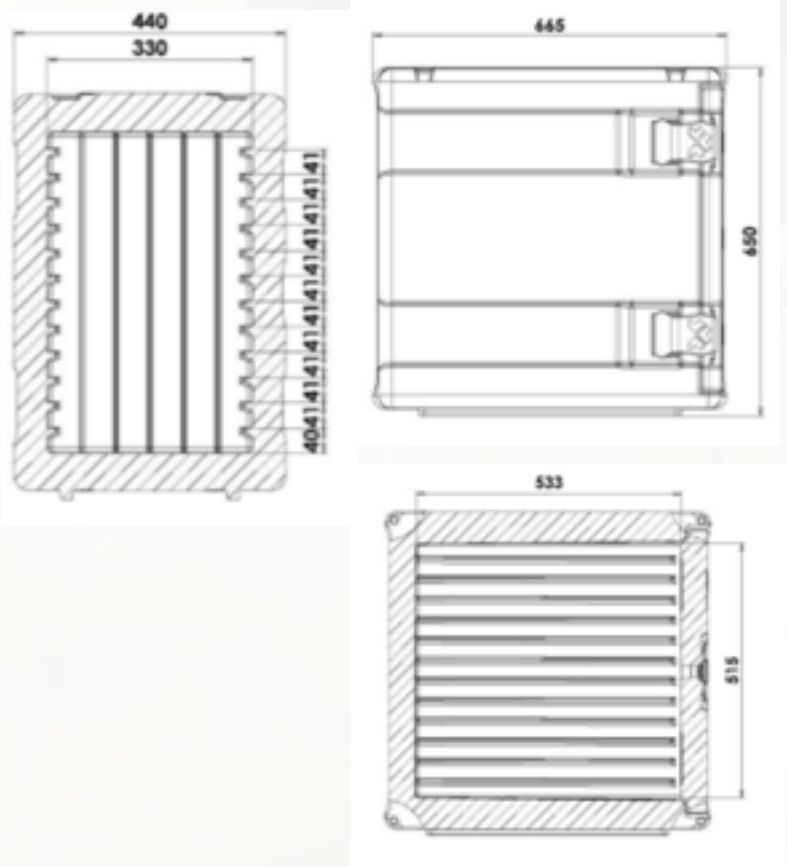

Portable Loo



Materials



- White ABS Plastic.

Powder Bags

- Supplied with 10 powder bags
- 100% bio-degradable.
- They immediately gelify all liquid waste thereby eliminating all spill risks during transport.

Transport Bag

- Slimline design
- Equipped with shoulder strap
- ID card holder

 Kg/oz	4.5kg
	Packed: 42 x 42 x 90 cm Unpacked: 42 x 42 x 43cm



The Portable loo is equipped with assembly instructions.



ACCESSORIES

Sand bagger



Code	CM999
 Kg/oz	21.21kg (46.7 lbs)
	Folded: 51 x 51.5 x 54.5cm (20 x 20.27 x 21.4") Assembled: 51 x 51.5 x 92.5 (20 x 20.27 x 36.4")

For flood defences, building and reinforcing defensive positions, quickly and easily. The time saved could save lives.

Sandbags (and lots of them) are essential for protection against blast, bullets and floods. When you need them you want them quickly. The BCB Sandbagger will help you produce all you need, right where you need them.

“Normally filling sandbags is a tiring two-person job with one of the two having to hold each bag as it filled. But the Sandbagger - which holds sandbags in a metal frame under a large hopper - allows one person to fill two bags at the same time”- Wales Online



Can be used with synthetic or Hessian types of sandbags

Can be erected in less than one minute

Quick fill and removal of sandbags

Can be used with dry soil, salt or aggregates

Plastic coated finish

Virtually maintenance free

Easy to use - little training needed

Few moving parts Easily portable and stackable Rust Proof

"The BCB sandbag filter is well-engineered and performed well during trials assessment. This would be the preferred equipment if a sandbag filler is required" - Extracts from the British Royal Engineers Report 2008 on the BCB Sand Bagger

Assuming a soldiers salary is \$20 per hour...

	By Hand	Using the Sand Bagger
Time to fill 100 sand bags:	182 minutes	88 minutes
Labour Cost to fill 100 sand bags:	\$60.66 (2 people)	\$29.33 (1 person)
Labour Cost to fill 5 million sand bags:	£3,033,000.00	\$1,466,500.00
Therefore: Saving per year using the Sand Bagger:	\$1,566,500.00 (or 50%)	

Time taken to recoup outlay on the sandbagger is **11 and a half hours**.

The BCB Sand bagger **collapses for easy transportation and storage** and can be erected in seconds.

All parts remain attached which eliminates the possibility of loss and the machine is **completely maintenance free**.

With the saving in labour cost the sand bagger will pay for itself in the first 11½ hours of use.

The wide mouth hopper combined with the unique twin bag slide system allows either:
 One person to fill 2 bags at once, or:
 Two people to fill sandbags continuously

Robust: The design loads structurally the strongest points.

Quality: High quality steel used throughout.

Compact: Folding legs reduces its size by half for transport, or storage. Eight per Euro pallet 120cm high. No detachable components to lose. Light enough for one person to carry.

Flexible: The feet allow it to be used in a soft, dry sand. It can be used with dry earth or shale. Its strength and its large hopper mean it can also be filled by a small mechanical digger

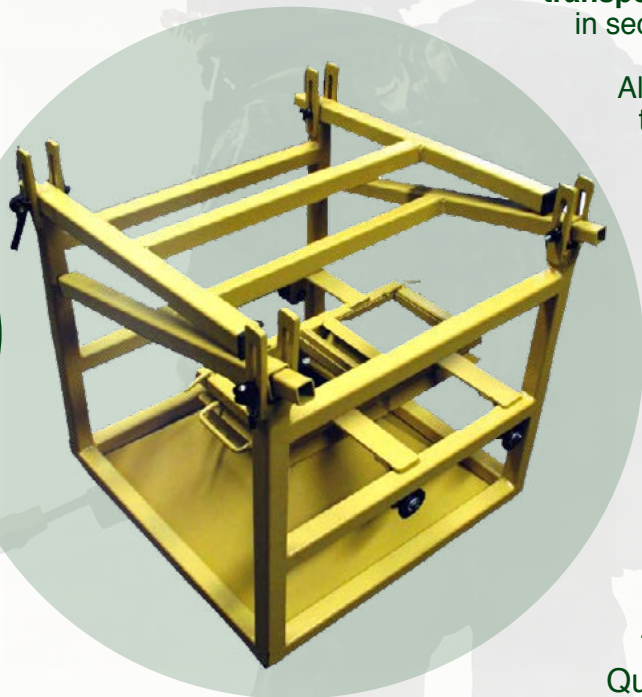

Fills more than twice as many sandbags per hour



Sand bags



Hessian Sandbag. Ideal for more robust uses that may require an extended temporary purpose, for example, continued flood prevention and defensive walls.

Code	CM999A
 Capacity:	28.5kg damp sand 25.5kg dry sand
	33x76cm (13x30")

Camouflage

Camouflages Nets

Reduces the thermal signature of hot objects

Quiet, rustle free, and matt anti-reflective printing

Suitable for all climatic conditions from -40°C to +70°C. Remains pliable in extreme temperature ranges

Non toxic, lightweight, waterproof garnish

Excellent colour fastness to U.V, water and abrasion resistance

Made to UK MoD specifications

Strong, durable and extremely robust



Woodland



Moorland / Mountain

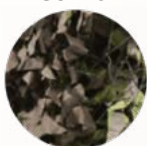

Desert



Artctic



Size	Metres	Feet	Woodland	Moorland/ Mountain	Desert	Artctic
2.4 x 2.1	8x7		●			
4.5 x 4.5	15x 5		●	●	●	●
7.5 x 7.5	25x25		●	●	●	●
9 x 9	30x30		●	●	●	●
11 x 11	36x36		●	●	●	●
11.5 x 5.5	38x18		●	●	●	●
11.5 x 11.5	38x38		●	●	●	●
12 x 6	40x20		●	●	●	●
12 x 12	40x40		●	●	●	●
14 x 12	46x40		●	●	●	●
16 x 16	53x53		●	●	●	●
18 x 18	60x60		●	●	●	●

Our camo nets are tested to and exceed the following UK MoD specifications:
 UK/SC/5094 Issue 14
 UK/SC/4830
 BS 3900
 BS 1006: 1990
 BS 3424: 1982
 BS EN ISO 2286: 1994
 BS EN ISO 2286-2
 BS EN ISO 1421: 1998

Watch our short video:

Standard Set Includes:

- 4' Pole x 4
- 8' Pole x 4
- Adaptor Sleeve x 8
- Spreader x 6
- Bag x 1
- Ground Stakes/Pegs x 24



BCB's camouflage nets can be made to your requirements. They come in various sizes and colours in order to camouflage almost anything.

BCB has been supplying the lightest camouflage systems to the UK MoD and to the international market for many decades. Over this time, BCB has built up a reputation as a market leader by delivering the best quality camouflaged goods on time and fit for purpose. Additionally nets can be supplied in any size and may be joined together to cover larger and even awkward terrain.



NATO Issue



Lightweight



Infra Red Reflection

- Used by British Army and many other NATO members in South America, Asia and Middle East.
- Shower resistant
- Perimeter edge cord
- Loops in each corner, and down long sides
- U.V treated, mould and rot resistant
- Strong



Camouflage

Nets



Lightweight and easy to carry

Multispectral - protects the wearer in the **visual, infrared and thermal** spectrums.



Camouflage net blocks thermal energy transmitted by the soldier

Features a random pattern to allow the camouflage to blend in with the irregularities of nature

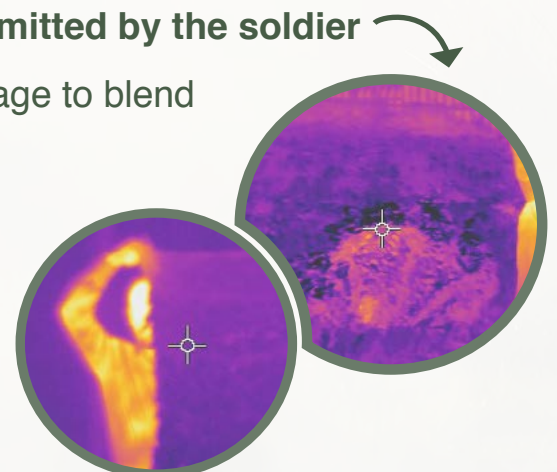

Patterns, colours and sizes can be customized according to customer requirements.

Code	Special Order - Please contact for more information
	1.33kg
	2x2 metres (6ft 6"x6ft 6")



Sniper Suit

- Constructed from a comfortable, bug-proof netting, which is hand-washable
- Made from durable lightweight polyester fabrics
- Rot and mould proof, fire resistant
- 3D leaf-like foliage
- Quiet and rustle-free
- Pre-made, no assembly required
- **Compactable and strong**
- **Reversible colour combinations for added concealment**
- Designed to **break up your outline, disrupt your landscape and disguise objects**
- **Non-toxic environmentally friendly**
- The system offered is a complete and ready to wear ghillie suit comprising of a hood, long jacket and trousers, all in 3D disruptive woodland camo netting



Code	RGKT01
 Kg/oz	2.6kg (5.7lbs)
 (Chest)	M/L: 95-110cm (38-44") XL/XXL:115-130cm (46-52")



Ghillie Suit

- 4 pieces set - **hood, jacket, trousers and gun cover**
- **Elastic/drawstring** at waist, chest, neck and cuff
- **Easy snap closure** on jacket
- **Adjustable chin strap** in hood
- **Ultra lightweight**
- **Removable knee and elbow pads**

Due to our continual product development, we reserve the right to alter or amend these products from what is shown, without prior notice.

Code	RGKT01A
 Kg/oz	1.39kg (3.06lbs)
 (Chest)	M/L 105-120cm (42-48") XL/XXL 120-140cm (48-56")



166 Years of lifesaving Innovation

OTHER RANGES FROM BCB:

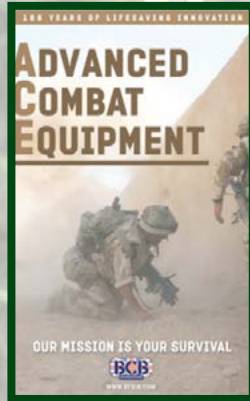

166 YEARS OF LIFE SAVING INNOVATION

Tel: +44 (0)29 20 433 700

Email: info@bcbin.com

Web: www.bcb.in.com

BCB International Ltd.
Howell House,
Lamby Industrial Park,
Cardiff,
CF3 2EX
Great Britain