



DR BROWNE'S



BCB INTERNATIONAL HEALTHCARE RANGE



BCB International Ltd
www.bcb.in.com

info@bcb.in.com
02920433700

PPE Products

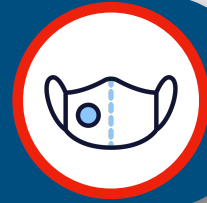

COVID Testing & Protection



Dr.Browne's Hand Sanitiser



Vaccination



Oxygen Products



Defibrillators



First Aid Kits



FFP3 Mask with Valve



- Traditional convex shape with nose clip.
- E-Valve design provides cooler and more comfortable wear.
- Inner face-seal ring.
- Reliable and effective protection against fine particles with high performance filter material
- Durable, collapse resistant inner shell
- Comfortable and lightweight 4-point adjustable straps
- Conforms to EN 149:2001 + A1:2009

CE Certified

ISO 9001

Code: CL291

>99%

BEF filtering capacity of particles with a mass median diameter of 0.3 micrometers

BEF: Bacterial Filtration Efficiency

Protection up to the corresponding threshold value (OELs).

30X



BCB International Ltd
www.bcb.in.com

info@bcb.in.com
02920433700

FFP2 Mask with Valve



- Traditional convex shape with nose clip.
- E-Valve design provides cooler and more comfortable wear.
- Inner face-seal ring.
- Reliable and effective protection against fine particles with high performance filter material
- Durable, collapse resistant inner shell
- Comfortable and lightweight 4-point adjustable straps
- Conforms to regulations EU 2016/425
- Conforms to EN 149:2001 + A1:2009

CE Certified

ISO 13485

EU 2016/425

Code: CL292A

>95%

BEF filtering capacity of particles with a mass median diameter of 0.3 micrometers

BEF: Bacterial Filtration Efficiency

4 layers of soft virgin non-woven protection

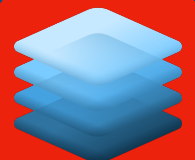

BCB International Ltd
www.bcb.in.com

info@bcb.in.com
02920433700

FFP2 Mask without Valve

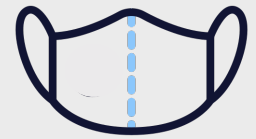

- Elastic ear loop.
- EN 149:2001
- Lightweight, skin friendly fabric.
- Adjustable nose bridge.

CE Certified

ISO 13485

Code: CL290

Can last up to 7 days depending on use

7 days

Light Usage

3 days

Medium Usage

8 hours

Heavy Usage

>95%

BEF filtering capacity of particles with a mass median diameter of 0.3 micrometers

BEF: Bacterial Filtration Efficiency

4 layers of soft virgin non-woven protection

Non woven protection waterproof layer

Non woven fabric

Melt blown fabric

Non woven fabric



BCB International Ltd
www.bcb.in.com

info@bcb.in.com
02920433700

Type IIR Disposable Masks

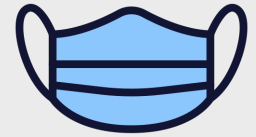

- Type IIR masks are fluid resistant. These medical face masks are intended to be worn to protect against the spread of transmission of infections germs as well as protecting against the splashes of liquids and particles.
- Outer layer: polypropylene non-woven fabric, water-repellent effect layer.
- Middle layer: provides a highly protective filter layer, bacterial filtration rates greater than 98% and particle filtration rate is greater than 95%.
- Inner layer: polyester soft skin-friendly non-woven fabric.
- Medical devices directive 93-42-EEC
- EN 14689 2019
- Standard EN14683

CE Certified

ISO 13485

Code: RK202

>98%

Bacterial Filtration Efficiency

BEF: Bacterial Filtration Efficiency



X50
Pcs.



BCB International Ltd
www.bcb.in.com

info@bcb.in.com
02920433700

Full Face Protective Shield



- Full Face protective shield is composed of three parts: a double-sided anti-fog transparent protective sheet, an elastic band and an anti-drop sponge. With a great anti-fog function which provides a clear vision for treatment.
- Widely used in medical activities for various tasks that require the operator's face protection.
- Complies with the Medical Devices Directive 93/42/EEC Annex VII Product: Medical face shield (Not Sterile) Class1

CE Certified

Class I

Code: CL223

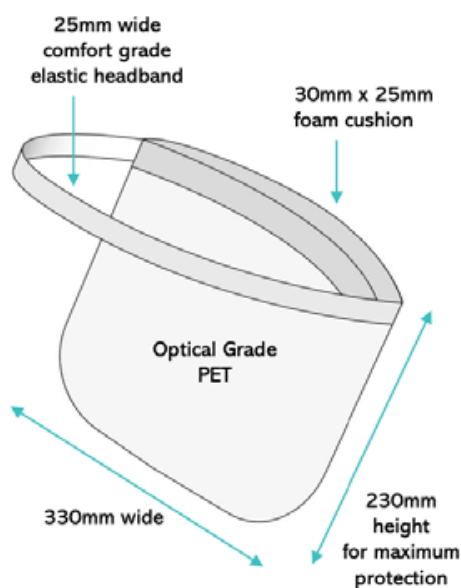

BCB International Ltd
www.bcb.in.com

info@bcb.in.com
02920433700

Thumb Loop Blue Gown

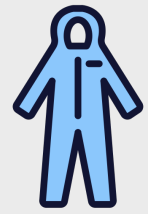

Code: CL300

- Our fluid resistant single use thumb loop gown offers the users a high degree of comfort and protection where low risk of fluid is present. Non-Sterile, mainly used in barrier helping to prevent the spread of infection from one person to another in hospital and for minor procedures within the hospital or community setting.

Features

- One size gives the wearer protection below knee and above the ankle
- Sleeves are long enough to ensure the arms are fully
- Waist ties are 65cm (+/-10%) and should not touch the floor when being worn
- Fluids Impervious gown >91cm H₂O
- Halter neck
- Latex free;
- Single use;
- low linting
- Anti-static
- All seams are welded

Colour: Blue
Material: LDPE Polythene 3mu
Dimension: 88cm (W) x 139cm (H)
Tie lengths: 65 cm (+/-10%)
Weight: 100g

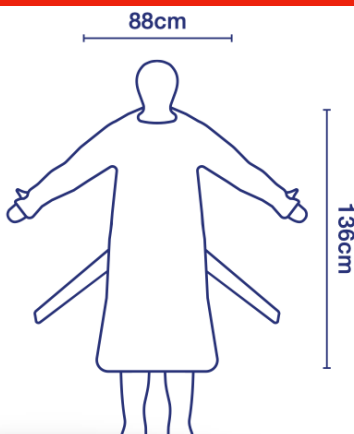

Thumb loop



BCB International Ltd
www.bcb.in.com

info@bcb.in.com
02920433700

Protective Safety Goggles



Code: CL501

- **Safety Goggles:** Double-sided Safety Goggles can protect your eyes by preventing air bacteria, viruses, smog, harmful chemical, dust from entering your eyes.
- **Anti-Fog:** The surface of the lens has an anti-fog coating, which can effectively prevent the formation of water mist.
- **360° Fully Protection:** Soft rubber and nose bridge attach around the goggles, good fit with nose pads, 360° fully protection, and more fit and comfortable.
- **Vent Design:** Adjustable vent design enhance air circulation, more comfortable to use.
- **High Transparent Lens:** High lens transparency rate keep clear vision, impact resistance as well.



Fully Protection

EU Regulation 2016/425



Note: The dimensions are measured manually with some tolerances.



BCB International Ltd
www.bcb.in.com

info@bcb.in.com
02920433700

Multipurpose Universal Disinfectant Wipes



Code: CL509

- kill at least 99.99% of bacteria and viruses. They can be used for cleaning and disinfecting surfaces, hands and equipment.
- Effective from just 10 seconds and can be used on visibly dirty hands. Our formulation is dermatologically tested and contains aloe vera and moisturiser to be gentle on skin. Trusted by healthcare professionals.
- Clean and disinfect in a single step
- Kills at least 99.99% of pathogens
- Resealable plastic lid



Effective from
just 10 seconds



kill at least 99.99% of
bacteria and viruses



BCB International Ltd
www.bcb.in.com

info@bcb.in.com
02920433700

Nitrile Gloves



- They have been designed for maximum sensitivity, dexterity and comfort, and offer increased elasticity and flexibility to reduce the risk of fatigue when in use for extended periods of time. These gloves are an essential piece of PPE (Personal Protective Equipment) and allow the wearer to use the gloves at ease and with additional reassurance that they are protected.
- Available in X-Small, Small, Medium, Large or X-Large.
- CE certified
- Powder Free 1 Outer Box can hold 10 boxes of 100 gloves.
- EU Regulation 2016/425

CE Certified

Code: CL505

XS

S

M

L

XL

X100
Pcs.



BCB International Ltd
www.bcb.in.com

info@bcb.in.com
02920433700

Dr. Brown's Hand Sanitiser



- Dr Browne's hand sanitiser, one of the strongest on the market, with an 80% alcohol concentration.
- Kills 99.9999% of viruses.
- Used widely by the NHS to provide premium protection.
- Can be used as a surface cleaner.
- Manufactured by BCB in Wales.
- Dr Browne's is approved to:
 - BS EN 14476:2013 + A2:2015
 - BS EN 1276:2019
 - BS EN 1500:2013
 - BS EN 13727:2012 +A2:2015
 - BS EN 13624:2013.

Available

50 ml

220 ml

475 ml

5 litre

Extra
Strength
Formula



Scented



Non-Scented



BCB International Ltd
www.bcbin.com



Dr. Brown's Hand Sanitiser

Read Cardiff
University Report

Based on a recent study conducted by Cardiff University it was found that **Dr Browne's** Hand Sanitiser is

> **1.6 more**
effective than
sanitiser containing
60% alcohol

> **2 more**
effective than Aloe
Vera Anti-bacterial
Hand-wash

≥ **6-log₁₀**
reduction
in viral load

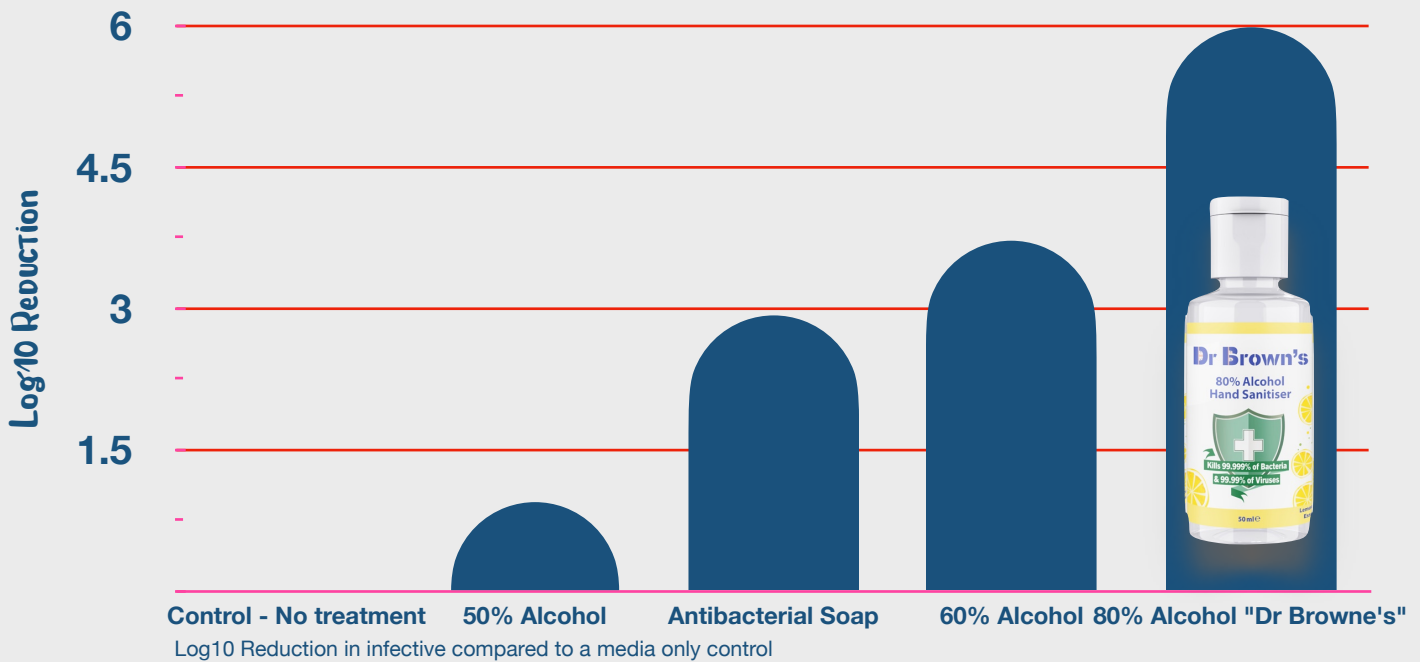

Kill
Rate %

0%

86.8712%

99.8774%

99.9109%

99.9999%

Ref: Bentley, K. & Stanton, R., Dr Browne's virucidal activity Testing, Cardiff University - School Medicine March, 2021



BCB International Ltd
www.bcb.in.com



Body Bag



Code: CS624

- Colour: White
- Material: 200 micron - PEVA
- Dimensions: 91x230cm
- Zip: U-shape for ease of access dual Pulls,
- Shelf life: 10 years (120 months)
- Special reinforced material (2ply) Non-PVC Toxic-free



Interlocking Style



Tags for toe



U-shape

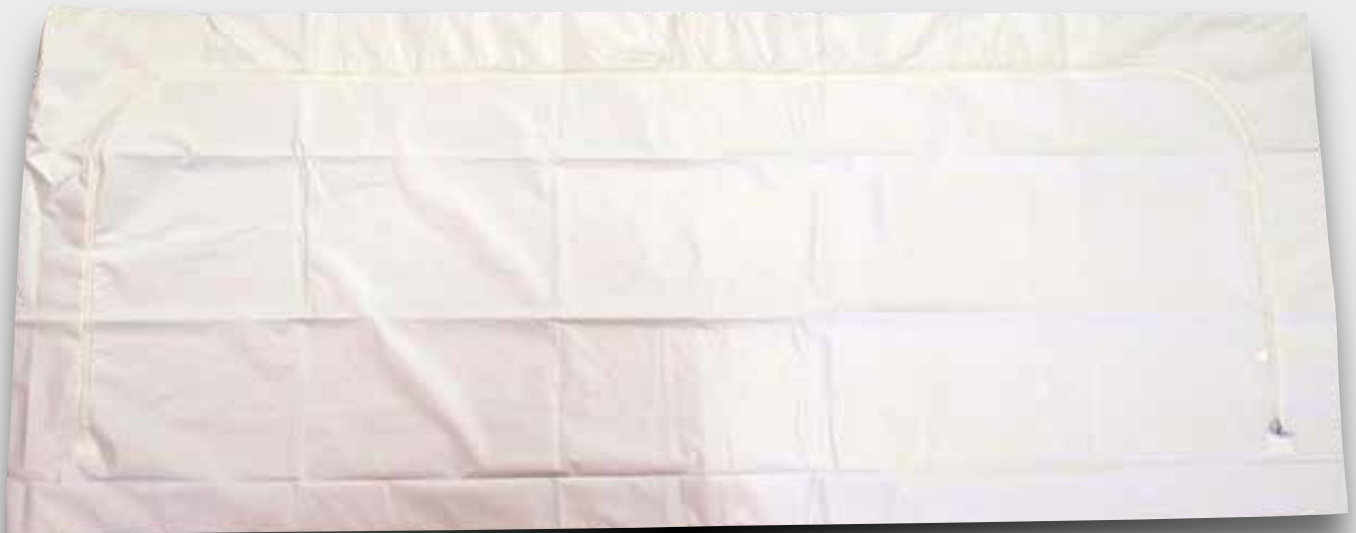

Infrared Thermometer

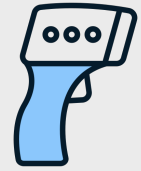

Code: CL504

This Infrared Thermometers design is simple and elegant. It can measure accurately without contact, making it cleaner and more sanitary. It has very good adaptability to environmental changes and can be used in complex environments. It will also register when the users measurements are 'safe', 'slight fever' and 'high temperature'. It comes with a forehead mode and a ear mode, with different heads for each. The probe cover is magnetic, keeping the probe virus free.

- 40 Memory Recalls
- Audio & Visual Fever Warning
- Mute Function
- BPA & Latex Free



1 second Fast Measurements

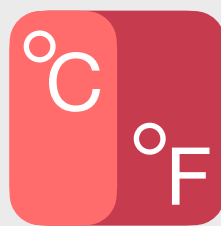

Celsius and Fahrenheit Measurements



Reusable Forehead Thermometer

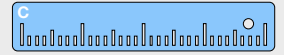

Quick, Simple and Reliable. Lightweight and robust, keep it handy.

CE Certified

Code: RM086

A range of Forehead and Anesthesia Temperature Indicators for the healthcare sector.

Liquid Crystal technology for the measurement of clinical temperature trends in the healthcare environment.

These liquid crystal thermometers are reusable and designed for use on the forehead area only and are an ideal way to estimate the core body temperature and check for temperature changes. Robust, quick reading can be used between clinical thermometer readings and to monitor trends.

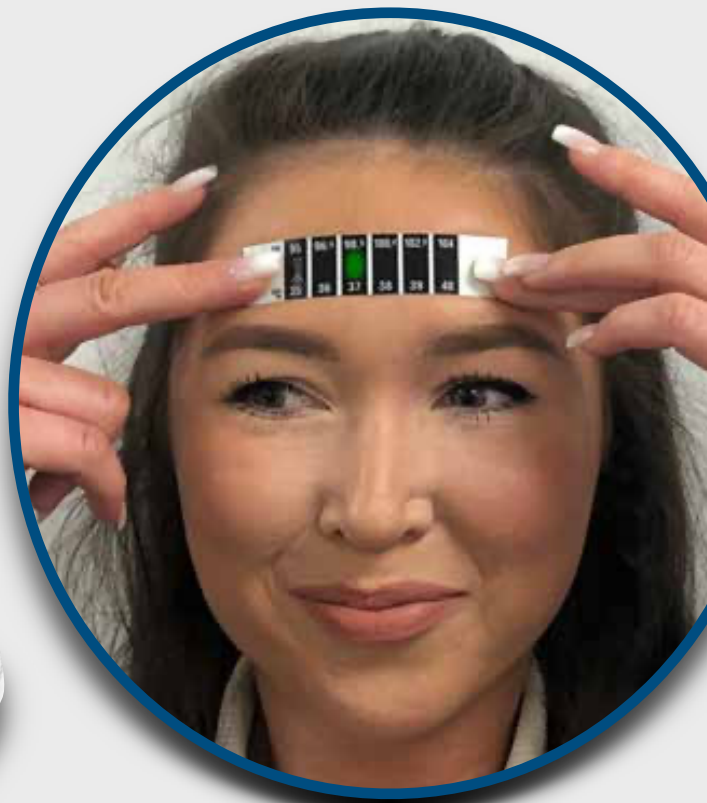
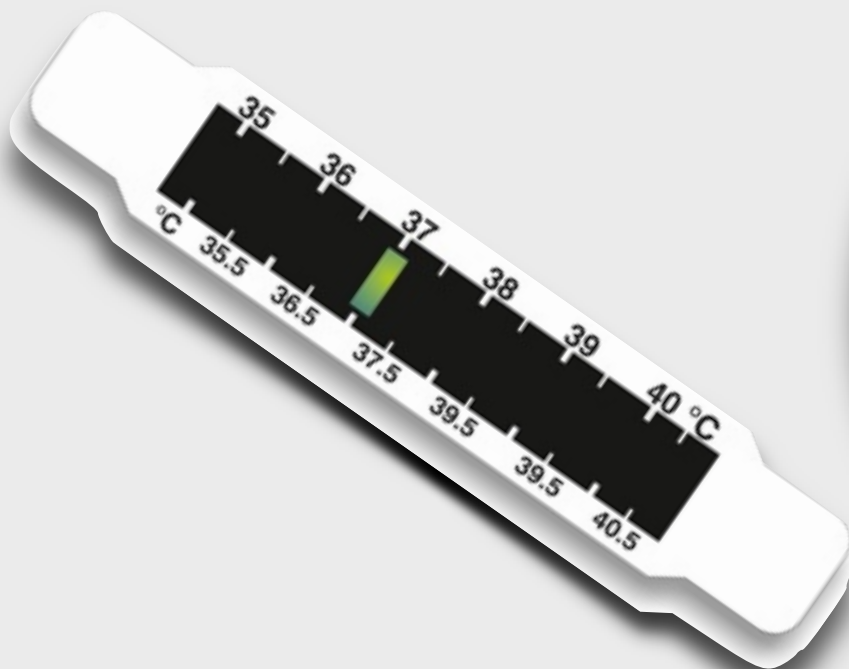

BCB International Ltd
www.bcb.in.com

info@bcb.in.com
02920433700

SARS-CoV-2 Antigen Rapid Test



The Coronavirus Ag Rapid Test Cassette (Swab) is an in vitro immunochromatographic assay for the qualitative detection of nucleocapsid protein antigen from SARS-CoV-2 in nasopharyngeal (NP) swab specimens directly or after the swabs have been added to viral transport media from individuals who are suspected of COVID-19 by their healthcare provider. To aid in the rapid diagnosis of SARS-CoV-2 infections.

CE Certified

Code: CL511

Performance Characteristics The Coronavirus Ag Rapid Test Cassette (Swab) has been evaluated with specimens obtained from patients. A commercialized molecular assay was used as the reference method. The results show that the Coronavirus Ag Rapid Test Cassette (Swab) has a high overall relative accuracy.

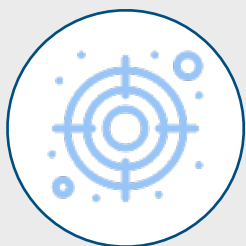

Relative Specificity
100%

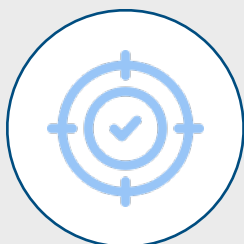

Accuracy
96.3%



Results within
15 minutes



Shelf life
24 months



Box contains:

- 20 Test cassettes
- 20 Sterile swabs
- 20 Extraction tubes and dropper tips
- 1 Workstation
- 2 Buffers
- 1 Package insert / instructions



BCB International Ltd
www.bcb.in.com

info@bcb.in.com
02920433700

Hypodermic Needle and Syringe



Combined Safety Sterile 1ml Syringe with 25G x 38ml (1.5 inch) Needle.

CE Certified

ISO 13485

Code	CL515	CL516
Needle/Syringe	Combined Pre-attached (Detachable)	Combined Pre-attached (Detachable)
Volume	1 ml	1 ml
Graduation	0.1 ml	0.1 ml
Needle	23G X 25mm (1 Inch)	23G X 38mm (1.5Inch)
Piston	Polyisoprene synthetic rubber	Polyisoprene synthetic rubber
Barrel	PP	PP
Plunger	PP	PP
Hub	PP	PP
Needle cap	PP	PP

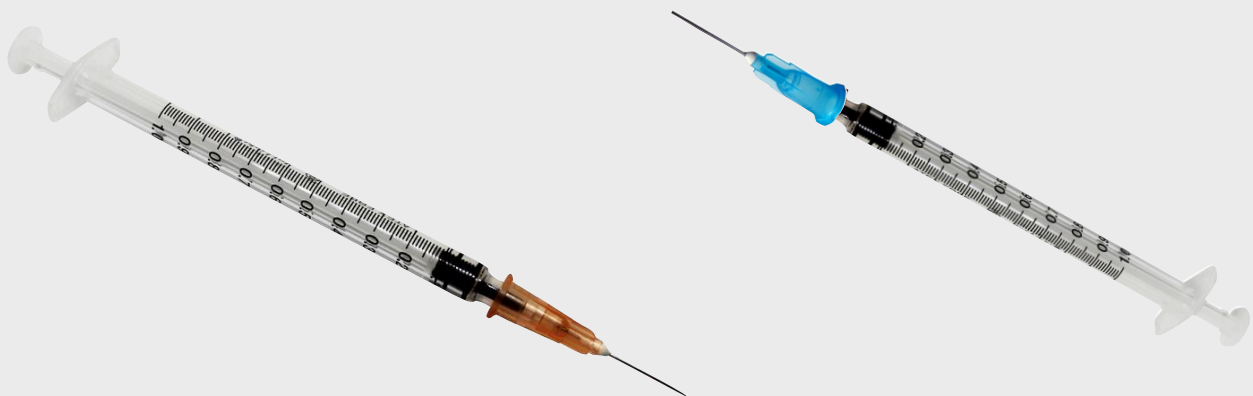

BCB International Ltd
www.bcb.in.com

info@bcb.in.com
02920433700

Hypodermic Needle and Syringe



Combined Fixed Retractable Safety Sterile 1ml Syringe with 25G x 38ml (1.5 inch) Needle.

CE Certified

ISO 13485

Code	CL517	CL518
Needle/Syringe	Combined Pre-attached (Fixed)	Combined Pre-attached (Fixed)
Volume	1 ml	1 ml
Graduation	0.1 ml	0.1 ml
Needle	23G X 25mm (1 Inch)	23G X 38mm (1.5Inch)
Safety feature	Retractable	Retractable

Retractable Safety needle

Be sure needle fix tightly and draw up medicine using standard procedure



1

Give injection using aseptic techniques, fully depress the plunger to lock the needle



2

Pull plunger back until needle fully be retracted into the barrel.



3

Snap off the plunger, the used needle will be encased inside the barrel

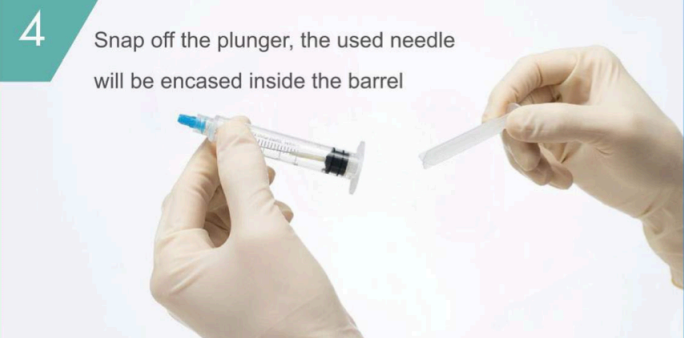

4

Oxygen Products



Code	Cylinders Specifications
676-0001-00	O2 CYLINDER, 40L STEEL, PIN INDEX VALVE - FILLED
676-0002-00	O2 CYLINDER, 40L STEEL, PIN INDEX VALVE
676-0029-00	O2 CYLINDER, 10L STEEL, PIN INDEX VALVE - FILLED
676-0030-00	O2 CYLINDER, 10L STEEL, PIN INDEX VALVE - EMPTY
676-0025-00	O2 CYLINDER, 5L STEEL, PIN INDEX VALVE - FILLED
676-0362-00	O2 CYLINDER, 2L ALLOY, PIN INDEX VALVE - FILLED
676-0361-00	O2 CYLINDER, 2L ALLOY, PIN INDEX VALVE - EMPTY

BAG VALVE MASK RESUSCITATION KIT SUPPLIED WITH REGULATOR

Code	Specifications
CTEX	Covid Air Assist Device
CON5	Oxygen concentrator 5 LPM output (2 Concentrators could be connected through a jointer to produce 10 LPM)
06-457	Oxygen Analyser, Model SenzTx-102 - 457
VEN001	Ventilator system/ WITHOUT VITAL SIGN MONITOR
670-0130-01	World Resuscitation Kit is designed for professional emergency services
670-0484-00	CPR Resuscitation Kit is designed for professional
670-0378-00	Kit for giving Oxygen therapy or Oxygen enriched mouth to mask resuscitation.
670-0425-00	Bag value mask resuscitation kit supplied with regulator



Regulators



Code	Cylinders Specifications
55B 677-0000-00	OXYGEN REGULATOR, PIN INDEX, THERAPY ONLY.
55B 677-0001-10	OXYGEN REGULATOR, PIN INDEX, 1 x BS SCHRADER THERAPY.
55B 677-0001-20	OXYGEN REGULATOR. PIN INDEX, 2 x BS SCHRADER THERAPY.
55B 678-0001-10	OXYGEN REGULATOR, PIN INDEX, 1 x BS SCHRADER.
55B 678-0001-20	OXYGEN REGULATOR, PIN INDEX, 2 x BS SCHRADER.
55B 691-0900-00	MEDICAL AIR REGULATOR, PIN INDEX, THERAPY ONLY.
55B 691-0908-10	MEDICAL AIR REGULATOR, PIN INDEX, 1 X BS SCHRADER, THERAPY.
55B 691-0908-20	MEDICAL AIR REGULATOR, PIN INDEX, 2 X BS SCHRADER, THERAPY.
55B 692-0908-10	MEDICAL AIR REGULATOR, PIN INDEX, 1 X BS SCHRADER.
55B 692-0908-20	MEDICAL AIR REGULATOR, PIN INDEX, 2 X BS SCHRADER.
55B 679-0100-00	OXYGEN REGULATOR, BULLNOSE INLET, THERAPY ONLY
55B 679-0101-10	OXYGEN REGULATOR, BULLNOSE INLET, 1 X BS SCHRADER, THERAPY.
55B 679-0101-20	OXYGEN REGULATOR, BULLNOSE INLET, 2 X BS SCHRADER, THERAPY.
55B 680-0101-10	OXYGEN REGULATOR, BULLNOSE INLET, 1 X BS SCHRADER.
55B 680-0101-20	OXYGEN REGULATOR, BULLNOSE INLET, 2 X BS SCHRADER.
55B 693-0100-00	MEDICAL AIR REGULATOR, BULLNOSE INLET, THERAPY ONLY.
55B 693-0108-10	MEDICAL AIR REGULATOR, BULLNOSE INLET, 1 X BS SCHRADER, THERAPY.
55B 693-0108-10	MEDICAL AIR REGULATOR, BULLNOSE INLET, 2 X BS SCHRADER, THERAPY.
55B 694-0108-10	MEDICAL AIR REGULATOR, BULLNOSE INLET, 1 X BS SCHRADER.



More options are available at
www.drbrownes.co.uk



CTEX Covid Air Assist Device



The CTEX Unit has been developed as a biological countermeasure to the Coronavirus pandemic with the UK Ventilator Challenge. One of only a few devices to gain MHRA Approval.

Clean sheet design to counter the threat of Covid-19 and builds on the Proven Benefits of providing Continuous Positive Airway Pressure (CPAP) for Covid-19.



MHRA Authorisation No.
RCX/016/003/019/121

OXYGEN: Only requires between 5-15 Litre/minute oxygen. ROI of 24hrs when compared to other devices on Oxygen use alone.

OXYGENATION: Delivers >70% Oxygen from only 15l/min. Can be used at home with an Oxygen Concentrator. No cylinders required.

Viral Filtration: CTEX draws in room air via two replaceable viral filters. Filters the air of all bacteria and viruses.

SEALED PATIENT CONSUMABLES: Less risk of viral aerosolization for staff and carers. Choice of Nose or Face Mask for convenience.

ANTI-VIRAL: Materials used minimise the lifespan of the Covid-19 virus.

Code	TECHNICAL Specifications
Electrical Voltage	230V 50-60Hz 115V 50-60Hz
Maximum Current	2 Amps (230V) 4 Amps (115V)
Oxygen	5-15 litres / minute (Depending on required FIO2 level)
Physical Dimensions	140 x 205 x 75mm
Weight	~2Kg
Noise	<60dBA
Standard Kit	CTEX CAAD Unit, 1 x Patient Kit (Flexible Tube, PEEP Valve, Filter, Medium Mask) & 1 x Fingertip oximeter
Maintenance Requirements	Every 24 hours; <ul style="list-style-type: none"> • Replace Patient Viral Filter • clean external surfaces
Between Patients	<ul style="list-style-type: none"> • Replace patient circuit • Replace viral inlet filter • clean external surfaces

Ventilator System



Including heated humidifier patient circuit, 0 – 70LPM high flow O2 therapy,+ Integrated Stand System. Pneumatic Oxygen powered ventilator

Specification:

- 2 ventilation modes: mandatory VCV and manual
- Suitable for adults and children over 10kg
- Airmix 100% or 50% Oxygen
100% Oxygen only version available
- Humidified patient circuit including a heated humidifier
- PEEP-Variable or Fixed
- Eliminates patient aerosol of contaminated exhaled gas
- No electrical power source required
- CE marked and ISO 13485 manufacturer
- Intubation/LMA device compatible
- Simple airway pressure indicator
- ZERO drive gas - This is the most efficient ventilation possible



VHB20

- Large LCD display with night view mode
- Dynamic control of temperature and humidity
- Individual control of expiratory heater wire
- Two modes: Invasive mode and non-invasive mode
- Safety enhanced alarm system, intuitive, fast response for errors
- Wide range of application: non-heated, single heated and dual heated breathing circuits

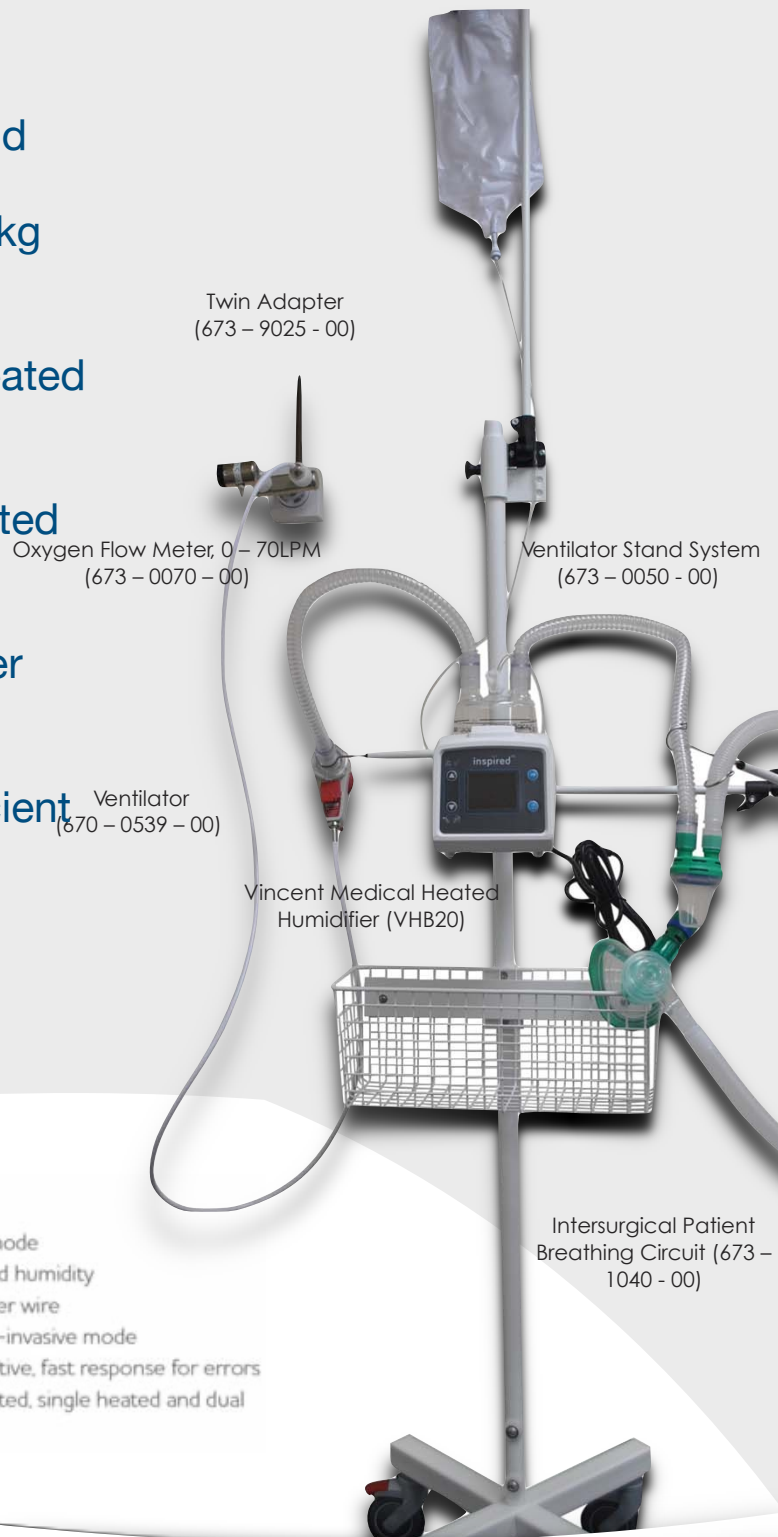

Portable Emergency & Oxygen Bags

More options are available at www.drbrownes.co.uk



670-0130-01

Designed for easy use, suitable for adults + children.

Kit includes:

- 1x Microvent™ World Advanced Automatic + Manual Resuscitator With 2M Hose
- 1x Pin Index Regulator, 1x BS Schrader, Therapy (0-15LPM)
- 1x Size 5 Resuscitation Mask, 1x Size 4 Resuscitation Mask, 1x Size 3 Resuscitation Mask
- 1x Size 1, Size 2, Size 3 + Size 4 Oropharyngeal Airways
- 1x Catheter
- 1x Adult High Concentration Oxygen Therapy Mask
- 1x Child High Concentration Oxygen Therapy Mask



670-0484-00

Designed for easy use, suitable for adults + children.

Kit includes:

- 1x Microvent™ CPR Advanced Automatic + Manual Resuscitator With 2M Hose
- Set to 10 BPM with 1 Second Inspiratory Time
- 1x Pin Index Regulator, 1x BS Schrader, Therapy (0-15LPM)
- 1x Size 5 Resuscitation Mask, 1x Size 4 Resuscitation Mask, 1x Size 3 Resuscitation Mask
- 1x Size 1, Size 2, Size 3 + Size 4 Oropharyngeal Airways
- 1x Catheter
- 1x Adult High Concentration Oxygen Therapy Mask
- 1x Child High Concentration Oxygen Therapy Mask



670-0378-00

Kit for giving Oxygen therapy or Oxygen enriched mouth to mask resuscitation. This kit includes:

- 1 x High concentration Oxygen therapy masks (adult)
- 1 x High concentration Oxygen therapy masks (child)
- 4 x Oropharyngeal airways
- 1 x Pocket mask
- Supplied in soft, wipeable bag.



670-0425-00

- 1 x single use BVM with adult (5), small adult(4) and child(3) masks in silicone
- 1x Oxygen reservoir system
- 1 X Pocket Mask
- 2 x High concentration Oxygen therapy mask (adult)
- 2 x High concentration Oxygen therapy masks (child)
- 4 x Oropharyngeal airways
- Supplied in a soft, wipeable bag.



BCB International Ltd
www.bcb.in.com



Oxygen concentrator 5 LPM



Molded handle that's easy to pick up and transport with one or both hands



Humidifier bottle holder compatible with all bottle styles



Internal tubing storage keeps tubing conveniently available for use



Metal cannula connector for greater durability



Recessed flow meter reduces the risk of breakage



Interface panel with on/off switch and alarm indicators



Product specifications

	Standard version	Low power version	IKK version
Power	230V/50Hz	230V/50Hz	230V/50Hz
Liter flow	0.5-5 liters per min	0.5-5 liters per min	0.5-5 liters per min
Sound level	43 dBA	43 dBA	< 40 dBA
Oxygen purity	90% - 96%	87% - 96%	87% - 96%
Weight	14 kg (32 lbs)	14 kg (32 lbs)	15 kg (33 lbs)
Dimensions (HxWxD)	580mm (22.8"), 380mm (15"), 240mm (9.5")	580mm (22.8"), 380mm (15"), 240mm (9.5")	580mm (22.8"), 380mm (15"), 240mm (9.5")
OPI (oxygen percentage indicator) alarm levels	Low oxygen: 82%, very low oxygen: < 70%	Low oxygen: 82%, very low oxygen: < 70%	Low oxygen: 82%, very low oxygen: < 70%
Required maintenance	Compressor intake filter: 2 yrs. Micro disk filter: as needed	Compressor intake filter: 2 yrs. Micro disk filter: as needed	Compressor intake filter: 2 yrs. Micro disk filter: as needed
Power consumption	< 300 W	< 300 W	< 300 W
Part numbers	1020006 Europe 1020009 South Africa 1020011 Italy 1020010 Australia 1020012 Argentina 1020013 South Korea 1020016 Hong Kong 1020017 Switzerland	1020008 UK, Ireland	1020007 Germany

Oxygen Sensors



The SenzTx is a compact and robust O₂ transmitter that utilises zirconia or electrochemical technology to give a reliable measurement of oxygen concentration.

Applications:

- Gas generation (oxygen / nitrogen)
- Additive manufacturing
- Glove box purge and leak detection
- Industrial gas applications

Features:

- Zirconia or electrochemical sensor technology options
- Measurement range: 0 to 10ppm up to 0 to 100% O₂
Analogue output: 4 to 20mA » Modbus 485
- 24VDC power supply
- M12 electrical connection
- Process connection: KF40 Flange or Flowthrough base
- Combined sensor and electronics allows for ease of integration.
- Fast reponse from ambient air to low
- Issue No. STX01_V2_EN_0720
- PPM oxygen measurement



Defibrillators

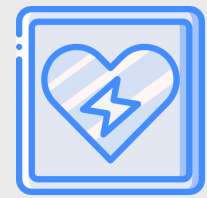

SAVER ONE CARRYING CASE

Description AED Carrying Case

Semi-Rigid, for reliable protection and transport of Saver One Defibrillators. Accessories and spare batteries can be stored in its inside compartments. Made of special shockproof and splash-proof material. Zipper opening and “D” ring to hook from the back.



Code: DEFACC04

SAVER ONE SEMI-AUTOMATIC PAD STANDARD 200J

User-friendly PAD reliable for any rescuer even without minimal training. Designed for public access use and licensed to administer fast and safe treatment against cardiac arrest, anytime and before the EMS team arrives. Practical, intuitive with CPR guidance and clear instructions supporting the rescuer through the protocol for an effective lifesaving action. Small and lightweight, works with long-life batteries for maximum portability. The right solution to save lives anywhere: home, offices, schools, hotels, ships, airports, trains, beaches, sports facilities, discos, dentists, etc.



Code: DEFIB001A

Dimensions: 26.5 x 21.5 x 7.5cm (10.4 x 8.4 x 2.9”) Battery options: disposable or rechargeable Power options: 200J or 360J

INDOOR WALL CABINET FOR SAVER ONE

Strong and lightweight Wall Cabinets are designed for indoor and outdoor storage for your AED. A clear polycarbonate cover and green polymer base ensure your AED is protected from harsh environments.



Code: DEFIB100

Grab & Go Bag



Code: CK080

Grab and go bag, quickly accessible and ready to keep you safe in any emergency. Strong, water-resistant material, making the Grab & Go Bag durable, strong, rip resistant and easy to clean.

5 large outer pocket all with double zips; so you can know where everything is and can access it quickly

Contents:

- 6 x 250ml Dr. Browne's Hand Sanitiser
- 8 x 50ml Dr. Browne's Hand Sanitiser
- 100 x Type IIR Masks
- 200 x Nitrile Gloves (Medium/Large)
- 5 x Face Shields
- 200 x Disinfectant Wipes
- 6 x Gowns
- 10 x Snap-seal Bags
- 1 Infrared Thermometer
- 3 x Ponchos



Advanced Personal Protection Pack



A small pouch, with a large capacity, to keep you safe in time of need. Fitted with a water resistant double zip, two belt loops and a clear internal pocket.

Code: CK074B

Contents:

- 50ml Dr. Browne's Hand Sanitiser
- 10 Sterile Wipes
- 2 x Type IIR Face Mask
- 10 Nitrile Gloves (Medium/Large)
- Information Leaflet
- First Aid Guide



Back 2 Work Kit

Code: CK073A

With many companies returning to work there is an uncertainty on how to stay safe. We have created packs of high quality products, tested by professionals, to keep you safe and reduce the spread of germs.

Contents:

- 50ml Dr. Browne's Hand Sanitiser
- Instruction Sheet
- 2 x Nitrile Gloves
- 3 x Antiseptic Wipes
- Forehead Thermometer
- Type IIR Mask
- 2 x Coin Towels

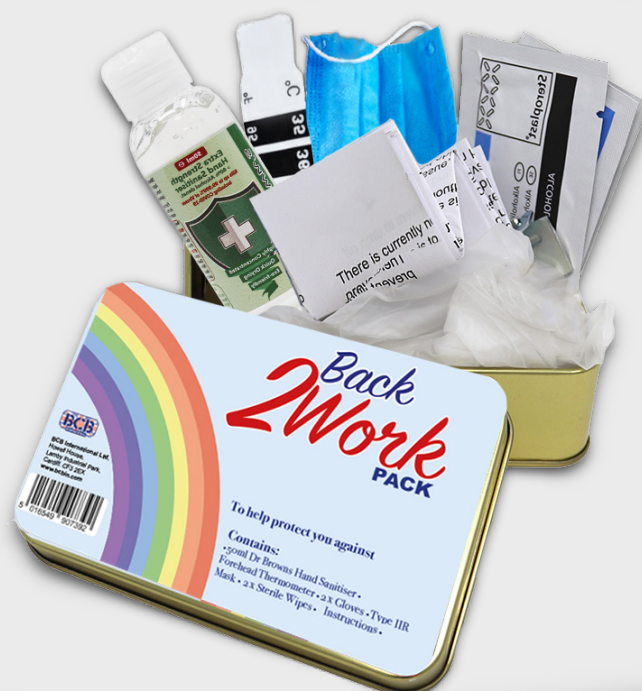

BCB International Ltd
www.bcb.in.com



First Aid Kit - Lifesaver #1



Code: CS111BX

Contents:

- 2 x Antiseptic wipes
- 10 x adhesive dressings
- Suture plaster
- Medium wound dressing
- Paraffin gauze burn dressing
- Triangular bandage
- knuckle "h" shaped bandage
- White open weave bandage
- Medical gloves (pair)
- Set of safety pins
- Scissors
- Accident evaluation report
- Crepe bandage
- Instruction leaflet
- Lifesaver pouch

15+
**Piece first
aid kit**



BCB International Ltd
www.bcb.in.com



First Aid Kit - Lifesaver #2



Code: CS110BX

Contents:

- 5 x Antiseptic wipes
- 10 x Adhesive dressings
- Suture plaster
- Medium wound dressing
- Medical gloves (pair)
- Set of safety pins
- Scissors
- Microporous adhesive tape
- Accident evaluation report
- Hospiform bandage
- Instruction leaflet
- Isotonic drink
- Lifesaver pouch
- Anchor dressings
- Conforming bandage
- Paraffin gauze burn dressing weave bandage

18+
Piece first
aid kit



BCB International Ltd
www.bcbintl.com



First Aid Kit - Lifesaver #3



Code: CS115BX

Contents:

- Resuscitation device
- isotonic drink
- 5 x antiseptic wipes
- Large crepe bandage
- Small crepe bandage
- Wound dressing No.8
- Eye dressing No.16
- Conforming bandage
- Hospiform bandage
- Anchor dressing
- Large ambulance dressing
- 10 x assorted adhesive dressings
- 2 x paraffin gauze dressing
- Triangular bandage
- 6 x safety pins
- Pair of scissors
- Pair of tweezers
- Strip fabric dressing
- Pair of disposable gloves
- Microporous adhesive tape
- 5 x Sutures
- Accident evaluation report
- Instruction leaflet
- lifesaver pouch

44+
Piece first
aid kit

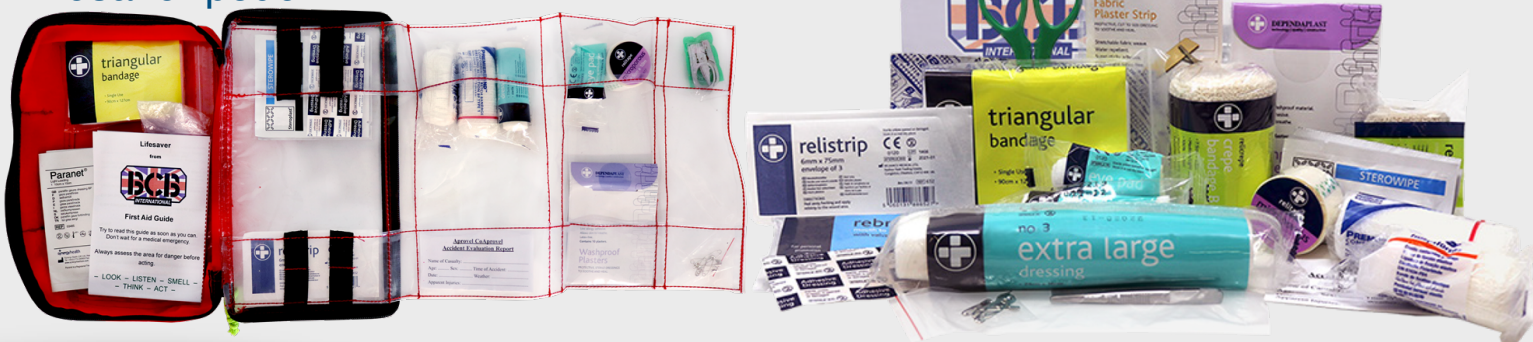

BCB International Ltd
www.bcb.in.com



First Aid Kit - Lifesaver #4



Code: CS119

Contents:

- Calico triangular bandage 90 x 127cm
- No.8 medium dressing
- No.9 medium dressing
- Conforming bandage 7.5cm x 4m
- Cotton gauze swabs
- Elastic adhesive bandage 2.5cm x
- Paraffin gauze 10x10cm
- First aid scissors
- Safety pins
- Burn bag
- Assorted waterproof plasters
- Lifesaver instruction leaflet.

50+
Piece first
aid kit



BCB International Ltd
www.bcb.in.com



First Aid Kit - Lifesaver #6



Code: CS124

Contents:

- Triangular bandage 90 x 127cm
- No.8 medium dressing
- No.2 ambulance dressing
- Cotton gauze swabs
- Extra large dressing No. 3
- Elastic adhesive bandage 7.5cm x
- Paraffin gauze 10x10cm
- First aid scissors
- PE gloves
- Burn bag
- Assorted waterproof plasters
- Zinc oxide tape
- Lifesaver instruction leaflet

60+
Piece first
aid kit



Lightweight First Aid Kit

Contents:

- Calico triangular bandage 90 x 127cm
- No.8 medium dressing
- No.9 medium dressing
- Conforming bandage 7.5cm x 4m
- Cotton gauze swabs
- Elastic adhesive bandage 2.5cm x 4.5m
- Paraffin gauze 10x10cm
- First aid scissors
- Safety pins
- Burn bag
- Assorted waterproof plasters
- Lifesaver instruction leaflet.



Code: CK702



x5 Personal First Aid Kit

Contents:

- 10 x Antiseptic wipes
- Adhesive dressings
- Medium wound dressing
- Triangular bandage
- Set of safety pins
- Accident evaluation report
- Instruction leaflet pouch

Code: CS476MBX



Resuscitator (with one way valve)

The Resuscitator with One Way Valve can be a life-saving piece of equipment for use in cardiopulmonary resuscitation (CPR – mouth-to-mouth resuscitation) events so it makes a lot of sense for one of these small devices to be in many people's first aid kit, for example.

Areas of use for this device would include accident and emergency, sports and leisure as well as general first aid responses.

- Lightweight and portable for use during CPR
- Ideal for anyone who may need to carry out first aid CPR or

CE Certified

Code: CS122

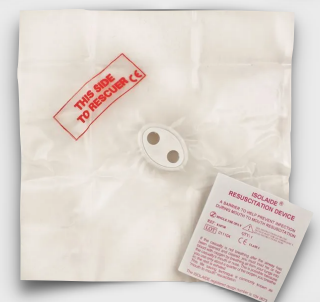

BCB International Ltd
www.bcb.in.com



Anaconda Splint



Can be used to immobilise and support broken or sprained limbs thus preventing further trauma. Ideal for inclusion in first aid kits, especially for field-based training and expeditions etc. These are very handy to even just keep at home, or keep in the scout hut in case of any injuries.

Code: RY273

Compact when rolled: 11 x 8cm (4.5 x 3")

Weight: 140g (5oz)

Length: 91cm (36") Open



ABOUT BCB INTERNATIONAL

For over 160 years, BCB International has built up knowledge and expertise in developing life-saving equipment for the frontline services. Our facility has held a MHRA GDP license for over 30 years, with a heritage of working with the UK government department and military, as well as exporting almost 40% of our products.

Our longstanding and loyal workforce have a wealth of experience in contract manufacturing, supply chain operations, testing and product development. These skills along with our innovation and passion guarantees consistency, quality and safety.

We've devoted our time, resources and investment into applying this knowledge when manufacturing hand sanitiser. We are currently supply to the Welsh and English NHS, British police forces, carehomes and other essential services.

We are here to protect the protectors and save lives. We won't let you down.



THE QUEEN'S AWARD FOR EXPORT ACHIEVEMENT



BCB International Ltd
www.bcb.in.com

info@bcb.in.com
02920433700