

166 YEARS OF LIFESAVING INNOVATION

# ADVANCED COMBAT EQUIPMENT

---

OUR MISSION IS YOUR SURVIVAL



[WWW.BCBIN.COM](http://WWW.BCBIN.COM)

# MEET THE TEAM



**Andrew Howell**  
Managing Director  
arh@bcbin.com



**Janey Howell**  
Managing Director Retail  
janey@bcbin.com



**Ben Simmons**  
Special Projects  
+44 7792 313 393  
bs@bcbin.com



**Paul Ames**  
International BDM  
+44 7974 373 954  
pa@bcbin.com



**Kate Graham**  
International Sales  
kg@bcbin.com



**John Rix**  
UK MoD Sales Manager  
+44 7773 540 858  
jrix@bcbin.com



**Phil Jones**  
UK MoD Sales Manager  
+44 7989 604 136  
pjones@bcbin.com



**Daisy Hoek**  
EU Sales Manager  
dh@bcbin.com

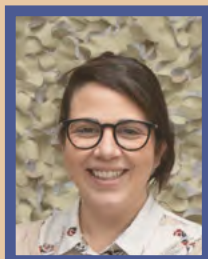

**Monica Catalano**  
EU Sales Manager  
mc2@bcbin.com



**Philippe Minchin**  
France BDM and  
Marketing Manager  
pm@bcbin.com



**Stephanie Frieze-Davies**  
Marine Sales Manager  
+44 7866 313 278  
sk@bcbin.com



**Stuart Morris**  
Marine BDM  
sm@bcbin.com



**Emily Howell**  
Marine Sales  
eh@bcbin.com

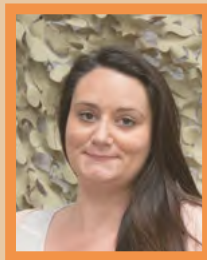

**Becky Ratcliffe**  
ROW Retail Sales  
Manager  
rr@bcbin.com



**George Carter**  
UK Retail Sales  
Manager  
gc@bcbin.com



**Khaoula Elghalmi**  
Middle East Sales  
ke2@bcbin.com



**Lisa Owen**  
Operations Manager  
+44 7866 313 278  
sk@bcbin.com



**Roland Abbott**  
Transport Manager  
ra@bcbin.com

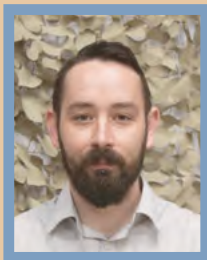

**Jay Rixon**  
Senior Graphic Designer  
jayr@bcbin.com

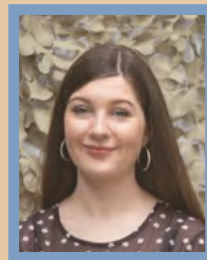

**Anja Quinn**  
Graphic Designer  
graphics@bcbin.com



**Kelsey Kellett**  
Director's PA  
kk@bcbin.com

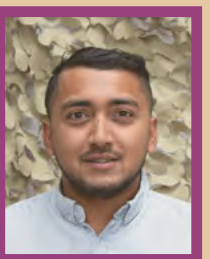

**Adnan Haddadi**  
Procurement Manager  
ahaddadi@bcbin.com



**James Firmin**  
Strategic Buyer  
jf@bcbin.com



**Jason Hodge**  
FireDragon Manager  
Jasonhodge@bcbin.com



**Ben Harrison**  
Chemist  
bh@bcbin.com



**“I will find a way, or make one”  
(Inveniam viam aut facium)**

These words from the great military commander, Hannibal, are a core value here at BCB International Ltd.

### **Passionate**

We are passionate about what we do and will work tirelessly to develop equipment solutions for you who go the extra mile for our security and safety.

### **Experience**

Drawing on our 166 years experience of supporting some of the world’s best military forces, this catalogue contains a selection of high quality innovative products we can offer you.

### **Survivability**

With hundreds of NATO approved products in our range, you can browse this catalogue knowing that our equipment is tested and proven and will not let you down in extreme conditions.

### **Just ask!**

This catalogue is just a snapshot of what we can offer. Simply ask if you cannot find what you are looking for.

We will endeavour to find a solution for you.

Inveniam viam aut facium!

At your service,

Andy

# **CONTENTS**

**COOKING** 5-22

**HYGIENE** 23-26

**SURVIVAL** 27-40

**CAMOUFLAGE** 41-50

**CAMP** 51-64

**CLOTHING** 65-86

**MEDICAL** 87-98

**TOOLS** 99-116

**SPECIALIST** 117-129



# BCB HISTORY

**1854**

Dr Brown invented Browns Cough Bottle (BCB) for the British troops in the Crimean War.



**1900**

Browns Cough Bottle was sold to the public in the UK.



**1979**

BCB International Ltd was established to develop the military range and export.



**1980's**

First supply to the United Nations.

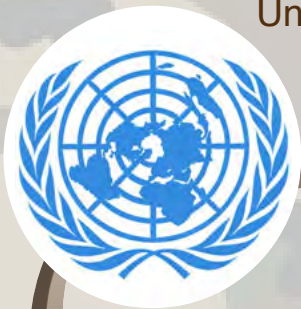

**1988**

Winner of first Queen Award for Export Achievement.



**1985**

Pioneer brand of outdoor accessories developed.



**1993**

LRQA ISO Quality Control approval.



**1999**

Robotic design begins.





**1914**

BCB Ltd. was established as a medical company, named after Brown's Cough Bottle.



**1940's**

First ever medical kit for life boats and rafts were designed and manufactured.



**1975**

Supply of medical equipment to the first successful expedition to the South West face of Everest.



**1967**

Developed shark repellent for the U.S. Navy.

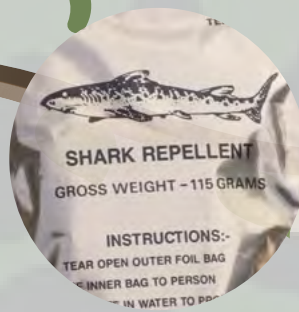

**1950's**

First supply to the British Ministry Of Defence

Brown's Cough Bottle Pastilles are made.



**2009**

Blast Boxers were designed.



**2014**

BCB Adventure was set up for the outdoor market.

**2007**

BCB International Inc. was established in the USA.



**2013**

FireDragon eco-friendly cooking developed.



# FIRELIGHTING

# FIREDRAGON

The green & clean ecofriendly fuel

**The cleanest solid fuel available today:**

### All weather

Rain, snow, extreme cold or searing heat, FireDragon performs in the most extreme weather conditions 

**No soot ✓**

**Low luminosity**   
Emits very little light when burning so as not to give away your position to the enemy

**No toxic fumes ✓**

**Easy to light**   
With just a spark, lighter, flint striker or match

### Packed safely with food

Easy to store and handle and can be safely packed together alongside food. Unlike many other cooking fuels, FireDragon does not contaminate or taint food 

### Long shelf life

FireDragon has a shelf life of 5+ years 

### Lightweight

Extremely lightweight with each block weighing in at only 27 grams. The blocks can be easily carried and stored in pockets, backpacks or webbing 

### Hand cleanser

FireDragon is a natural disinfectant and can also be used as a waterless soap. Ideal when in the field just before cooking and eating 



All Weather



Hand Cleanser



# A waterproof, easy to light, non-toxic, and powerful cooking fuel

Watch FireDragon in action:



## Eco friendly

Made from sustainable, naturally derived bio-ethanol



## Non-toxic & odourless

Unlike other cooking fuels, FireDragon burns without any noxious or toxic fumes. It can also be used indoors (with suitable airflow)



## Compatible with most cookers

Can be used with a variety of portable cookers



## Fast boil & long burn

A block of fire dragon burns for approximately 8 minutes (2 blocks - 12 minutes) and boils 500ml of water in just 5 minutes



## Air transportable

Safe to be packed and transported on cargo



## High calorific value

Of 29,000 (kj/kg)



## Clean burn

Burns with very little soot or residue so doesn't dirty cooking equipment



## Made in the UK

Sourced from British grown grain stocks and made in South Wales



## Patented

Unique patented technology granted worldwide. There is no other cooking fuel like it on the market



Quick & Easy to Light



Clean Burn



# FIRELIGHTING

# FIREDRAGON



## FIREDRAGON SOLID FUEL



A new, innovative & environmentally friendly solid fuel

Non-toxic and odourless

Highly effective, high burn fuel

Easy and quick to ignite

Very little soot given off, so doesn't dirty your cooking pot or mess tin

Easy to store and handle

Each block will burn for about  
**8 minutes**

Will light & burn **even when wet**

Can be used with a **variety of cookers**

Made from **sustainable, natural biofuel**

Air Transportable:  
UN Class 4.1 Packing Class III

- NON-TOXIC** ✓
- ODOURLESS** ✓
- 100% NATURAL** ✓



Our lightweight, easy to open  
**military packaging**

|      |                                 |
|------|---------------------------------|
| Code | CN336G                          |
| NATO | NSN-9110-99-426-2694            |
|      | 6x 27 grams (0.9oz)             |
|      | 40 x 67 x 25mm (1.5 x 2.6 x 1") |

+44 (0)29 20 433 700

www.bcbin.com



In the driving rain, the freezing Arctic, at high altitudes or searing heat, FireDragon will perform in the most extreme conditions



## FIREDRAGON GEL FUEL

Easy and clean to use



Our all-weather gel biofuel derived from FireDragon Solid fuel technology

Made from a high purity of ethanol, FireDragon gel fuel can be used in multi-fuel outdoor cooking stoves, and barbecues, as well as for fire lighting

Ideal in the outdoors to cook your rations and boil your brews quickly, safeguard your health, while protecting the environment

Research shows that FireDragon boils water quicker than all other non-gas fuels

| Code  | CN348A | CN349A  |
|---|--------|---------|
|  | 200 ml | 1 litre |



@FireDragon\_fuel



@FireDragonfuel



@FireDragonfuel

COOKING

HYGIENE

SURVIVAL

CAMO

CAMP

CLOTHING

MEDICAL

TOOLS

SPECIAL



# COOKING

## FIRE DRAGON



Easy to use

Waterproof

Compact

Reusable

MOD Issue

Efficient

Lightweight

Comes with attachable wind shield



This high quality cooker is made from aluminium, and is small and lightweight

The central fuel receiver helps to improve the burn efficiency so improving your cooking time and reducing the amount of fuel you need. You can store 3 FireDragon solid blocks inside the folded closed stove. Ideal while carrying and storing.



(FireDragon fuel tablets not supplied)



|             |                             |
|-------------|-----------------------------|
| <b>Code</b> | <b>CN337</b>                |
| <b>NATO</b> | NSN-7310-99-587-4226        |
|             | 110 grams (3.8oz)           |
|             | 11.5x7x2.5cm (4.5x2.7x0.9") |

+44 (0)29 20 433 700

www.bcbin.com





The FireDragon Mini Cooker is a smaller, lighter alternative to the FireDragon multi-fuel cooker

- ✓Lightweight
- ✓Compact
- ✓Robust

The metal can be folded to suit the size of different cooking pots

In ideal cooking conditions the wind shield and vent can be adjusted for a more intense burn

Two FireDragon fuel tablets can be stored in the cooker to save storage space while travelling

|   |                           |
|---|---------------------------|
| <b>Code</b>   | <b>CN360</b>              |
|  | 40 grams (1.4oz)          |
|  | 7x5x4cm<br>(2.7x1.9x1.5") |

## MRE - MINI COOKER



(FireDragon fuel tablets not supplied)





## COOKING SET MKIII



This new and improved cooking set featuring strong, lightweight and high quality material components



Includes:

- Silicone cup lid (see page 14)
- Canteen water bottle
- Aluminium cooking cup
- Aluminium multi-fuel cooker

### Complete Cooking Set

|   |                              |
|---|------------------------------|
| <b>Code</b>   | <b>CN030</b>                 |
|  | 510 grams<br>(18oz)          |
|  | 23x12.5x9cm<br>(9x4.9x3.5")  |
|  | 152 grams<br>(5.4oz)         |
|  | 12x14x10cm<br>(4.7x5.5x3.9") |

|   |                             |
|---|-----------------------------|
|  | 206 grams<br>(7.3oz)        |
|  | 19x12x8cm<br>(7.4x4.7x3.1") |

|   |                                |
|---|--------------------------------|
|  | 152 grams<br>(5.4oz)           |
|  | 8.5x12.5x9cm<br>(3.3x4.9x3.5") |



# COOKING

## THE DRAGON MULTI-FUEL COOKING SYSTEM

A strong all-in-one 5 piece cooking set

Each item fits neatly inside the other, making the entire cooking system compact and easy to carry

Hard-anodised metal cup is easy to clean

Multi-fuel cooker works perfectly with our FireDragon fuel, available as solid or gel

The pouch can be molle mounted onto belts, rucksacks or body armour - comes in black or multicam



Drinking Cup



Heavy Duty Water Bottle

Cooking cup

Multi-fuel Cooker

Pouch

You may like to add the silicone lid - see page 14

|   |   |
|---|---|
| Complete Cooking Set  |   |
| Code  | CN017C  CN017B  |
|  | 838 grams (29.6oz)  |

www.bcbin.com +44 (0)29 20 433 700



# THE DRAGON MULTI-FUEL COOKING SYSTEM:

Heavy duty, strong and robust

Doubles as a cooking pot and features a special heat receptor on its base. Fold out handles

Aluminium cooking cup

Plastic drinking cup

Canteen water bottle

Stainless steel multifuel cooker  
With a fuel chimney to enhance burn

Belt mounted carrying pouch  
Perfect accessory with separate compartment for the cup lid. MOLLE compatible

Available in black or camo

All items can be purchased separately:



Multifuel Cooker

Cooking Cup



Drinking Cup



Carrying Pouch

Water Bottle

|   |                               |
|---|-------------------------------|
| Code  | CN006                         |
|  | 180 grams (6.3oz)             |
|  | 11.4x10.2x8.9 cm (4.5x4x3.5") |

|   |                   |
|---|-------------------|
| Code  | RP540C            |
|  | 190 grams (6.7oz) |
|  | 950ml             |

|   |                   |
|---|-------------------|
| Code  | CR244B            |
|  | 110 grams (3.9oz) |
|  | 580ml             |

|   |                             |
|---|-----------------------------|
| Code  | CA815BLK                    |
|  | 118 grams (4.2oz)           |
|  | 11.7x8.2x5cm (4.6x3.2x1.9") |

|   |                   |
|---|-------------------|
| Code  | CR244B            |
|  | 140 grams (4.9oz) |
|  | 1 litre           |



COOKING

HYGIENE

SURVIVAL

CAMO

CAMP

CLOTHING

MEDICAL

TOOLS

SPECIAL



# COOKING

Constructed of high-grade stainless steel. The cup canteen is designed to fit beneath the NATO water bottle as part of the BCB Complete Cooking System



Available with a black PTFE coating which makes it easier to clean

Doubles as a cooking pot

|             |  |
|-------------|--|
| <b>Code</b> | <b>CN540</b> ●<br><b>CN540B</b> ●                  |
| <b>NATO</b> | NSN- 6850-99-798-5980 ●<br>NSN- 8465-99-721-3131 ● |
|             | 290 grams<br>(9.6oz)                               |
|             | 13.7x10.2x10mm<br>(5.3x4x4")                       |
|             | 750ml (1.58 pints)                                 |

## CUP CANTEEN



## DRAGON COOKER



### Multi-fuel

Internal chimney helps to improve burn efficiency

Vent hole helps to retain as much heat as possible and funnel the airflow for effective fuel burn

|             |                            |
|-------------|----------------------------|
| <b>Code</b> | <b>CN006</b>               |
|             | 152 grams (5.3oz)          |
|             | 12.5x11x8cm (4.9x4.3x3.1") |

### Heavy duty material



Screw top closure

British army style

Plastic cup with handle

Issue (58 pattern)

|             |  |
|-------------|--|
| <b>Code</b> | <b>CR244A</b><br><b>CR244B (NATO)</b>                  |
| <b>NATO</b> | NSN- 8465-99-9736665<br>(CR244B)                       |
|             | 227g (8oz)   |
|             | Mug - 500ml (16.9 fl oz)<br>Bottle - 950ml (32.1fl oz) |

## WATER BOTTLE & MUG



+44 (0)29 20 433 700

www.bcbin.com



## AIRBOURNE COOKING CUP MKIII



Aluminium is quick to heat

Heat retention indent on bottom increases the surface area so the contents cook quicker



2 Steel folding handles

Shaped base with a larger surface area to generate as much heat as possible

Hard anodised - easier to clean

Light weight aluminium

Larger than issued cup canteen

|   |                             |
|---|-----------------------------|
| <b>Code</b>   | <b>CN540D</b>               |
|  | 204 grams (7oz)             |
|  | 13x10x11.5cm (5.1x3.9x4.5") |

High temperature silicone lid

**Improves heat retention**

Stops debris from an open fire getting into cup

**Expands on heating to give a good tight fit**

|   |                      |
|---|----------------------|
| <b>Code</b>   | <b>RP009D</b>        |
|  | 37 grams e (1.3oz e) |
|  | 14.5x10cm (5.7x3.9") |



## SILICONE CUP LID



**Molle fastening pouch for the complete cooking system**

Available in multi-camo print or black

**Tough, durable material**

|   |   |
|---|---|
| <b>Code</b>   | <b>CA815M</b>    |
|   | <b>CA815BLK</b>  |
|  | 32 grams (1.1oz)  |

## DRAGON COOKING SYSTEM POUCH





# FIRELIGHTING

## GRAND FIREBALL

Two highly effective flint and strikers, both with a compass

Both designs are comfortable and safer to use

Features a small liquid filled button compass in the handle

The Grand flint and striker slide and lock neatly together; no string necessary

The long flint gives a great shower of hot sparks





## MINI FIREBALL

Lightweight

Compact

Separate hardened hacksaw blade creates a large striking surface area with its teeth



| Product   | Grand            | Mini             |
|---|------------------|------------------|
| Code  | CN340            | CN340M           |
|  | 50 grams (1.6oz) | 40 grams (1.3oz) |
|  | 11cm (4.5")      | 8cm (3")         |

+44 (0)29 20 433 700

www.bcbin.com



Flint adhered to a **magnesium block**

This burns readily and very hot so is an **ideal catalyst to ignite your tinder**

Can be used for starting **thousands of fires**

## MAGNESIUM FIRE FLINT



Scrape shavings off the magnesium block with the hacksaw blade

Then ignite these by striking the blade down the flint **showering sparks onto the magnesium**

|             |                      |
|-------------|----------------------|
| <b>Code</b> | <b>CN331</b>         |
| <b>NATO</b> | NSN-5120-99-471-3046 |
|             | 15 grams (0.5oz)     |
|             | 7.62cm (3")          |

The **most compact flint & striker** designed to fit into the smallest survival kit

Scraping the flint produces a **shower of sparks**, suitable for lighting tinder

|             |               |
|-------------|---------------|
| <b>Code</b> | <b>CN330D</b> |
|             | 24g (0.8oz)   |
|             | 7.6cm (3")    |

The striker can be used as a small knife or saw

Long lasting



## RANGER FIRE FLINT



## MATCHLESS FIRE SET

This kit has the advantage of **lasting much longer** than a box of matches and its components are sealed

Easy opening  
Will work in the rain

|             |                      |
|-------------|----------------------|
| <b>Code</b> | <b>CN021</b>         |
| <b>NATO</b> | NSN-4220-99-403-2117 |
|             | 125 grams (0.8oz)    |
|             | 15x130x3cm (3.9")    |



Contains 3 FireDragon solid fuel blocks, 6 cotton wool balls, and a ranger fire-lighting flint

**Much stronger and more effective than a standard match**



These matches have extra long heads and will **continue to burn through strong winds and rain**

Hand-dipped and varnished

|             |                    |
|-------------|--------------------|
| <b>Code</b> | <b>CN343</b>       |
|             | 45 grams (1.6oz)   |
|             | 3x5.5cm (1.1x2.1") |

Each waterproof container includes **25 matches**

Each match burns for **over 10 seconds**

## SURVIVAL MATCHES







# RATIONS

## RATION HEATING KITS

Our two new lightweight, compact heating kits are perfect for hot food rations. Both feature one of our new flat packed cooker designs as well as our patented environmentally friendly FireDragon Fuel in a unique 7.5 gram (0.3oz) ready to use capsule.

- Folding Stove • Gripping Lever
- FireDragon Capsules 3 x 7.5 gram (0.3oz)
- Book of Safety Matches x8
- Refuse Bag

|   |                            |
|---|----------------------------|
|   | Small                      |
| <b>Code</b>   | CN364                      |
|  | 72 grams (2.5oz)           |
|  | 48x118x19mm (1.8x4.6x0.7") |



### SMALL





### LARGE





- Folding Stove • Gripping Lever
- FireDragon Capsules 6 x 7.5 gram (0.3oz)
- Book of Safety Matches x20
- Refuse Bag (5 litre)
- Wooden Toothpicks x3
- Water Purifying Tablets x6



|   |                          |
|---|--------------------------|
|   | Large                    |
| <b>Code</b>   | CN363                    |
|  | 102 grams (3.5oz)        |
|  | 91x102x19mm (3.5x4x0.7") |

- Content:**
- Energy bar
  - Survival Instructions
  - Purification Tablets
  - Coffee set
  - Whistle
  - Matches
  - Compass
  - Mint cake
  - Wire
  - Boiled sweets

**900 kcal**

|   |                      |
|---|----------------------|
| <b>Code</b>   | CP670                |
|  | 280g (10oz)          |
|  | 17.5x23x5cm (7x9x2") |

## EMERGENCY RATION PACK VI

Includes food and survival items



A compact hermetically sealed aluminium package, which can be used as a brew pot, containing high energy food, coffee set, fuel, purification tablets, compact survival items and instructions.







## 24 HOUR MRE RATION

The 24 hour pack is formulated to provide 3000 to 4000 kcal with a range of meals, beverages and snacks to compliment the main entrees.



A typical pack would include porridge oats or granola for breakfast, tea or coffee, crackers cheese and biscuits. The main meal would have an entrée and a starch with an energy bar or fruit.

The evening meal could also include a soup, an entrée and a snack with tea and coffee to follow

|   |                                    |
|---|------------------------------------|
| <b>Code</b>   | CP020                              |
|  | 1.6kg (3.5lbs)                     |
|  | 26.4x17.6x8.6cm<br>(10.4x6.9x3.4") |

Vacuum packed  
3 Year shelf life  
Energy: 409 kcal

More flavours available

|   |   |
|---|---|
| <b>Code</b>   | RF0014R (Raspberry)<br>RF001T4 (Cherry) |
|  | 84 grams (3oz)                          |
|  | 16x6x1.5cm (6.3x2.4x0.6")               |

## MILLENNIUM ENERGY BAR





## BARLEY SUGAR RATION



Barley sugar sweets sealed in a waterproof tin

Long shelf life as they are double hard boiled

The tin can be used as an emergency cooking pan

|   |                             |
|---|-----------------------------|
| <b>Code</b>   | MM108                       |
| <b>NATO</b>   | NSN-8970-99-700-2104        |
|  | 170 grams (6oz)             |
|  | 11x8.2x2.8cm (4.3x3.2x1.1") |







# COOKING UTENSILS

A super lightweight, airtight aluminium tin with locking roller clasps

Features a rubber seal within the lid

Useful as a storage tin for personal survival equipment

|   |                        |
|---|------------------------|
| <b>Code</b>   | <b>CN550</b>           |
|  | 95 grams (4oz)         |
|  | 13x9x3cm<br>(5x3.5x1") |

## MINI MESS BOX





## STACKABLE MESS TINS



These aluminium stacking tins fit neatly together and the handles fold in, saving vital storage space

Easy to clean and maintain





|   |                             |
|---|-----------------------------|
| <b>Code</b>   | <b>CN246</b>                |
| <b>NATO</b>   | NSN-7350-99-449-0184        |
|  | 480 grams<br>(21oz)         |
|  | 18x13.5x6cm<br>(7x5.3x2.4") |



These wooden sporks, made from birch wood are stronger and more durable than their plastic counterparts

Biodegradable and better for the environment

|   |  |
|---|--|
| <b>Code</b>   | <b>CN230 (Pack of 10)</b>                |
|  | 26 grams (0.9oz)                         |
|  | 15.8 x 3.3 x 2.5cm<br>(6.2 x 1.3 x 0.9") |

## WOODEN SPORKS







## LIGHTWEIGHT KFS SET



The traditional camping knife, fork and spoon set



The knife & fork clip onto rivets on the spoon handle

Handy bottle opener on knife

|  |   |
|--|---|
| Code   | CN1446                                    |
|  | 75 grams (2.7oz)                          |
|  | 26.7 x 8.9 x 0.6cm<br>(10.5 x 3.5 x 0.2") |

Strong stainless steel

A knife, fork, spoon and can opener set that slides neatly together



|  |                          |
|--|--------------------------|
| Code   | CN224                    |
|   | 164 grams (5.8oz)        |
|  | 19x45x2cm (7.4x1.7x0.7") |

## KFS SET WITH CAN OPENER



Folds down to half its size

High quality material: 410 stainless steel

|   |   |
|---|---|
| Code  | CN222                                       |
|  | 28 grams (1oz)                              |
|  | Closed: 10cm (3.9oz)<br>Open: 15.8cm (6.2") |



## FOLDING SPORK



Strong, lightweight and robust can opener

Two per pack

Can be attached to a key ring/lanyard

|   |                          |
|---|--------------------------|
| Code  | CN225                    |
| NATO  | NSN-7330-99-549-6287     |
|  | Closed: 5x2cm (1.9x0.8") |
|  | 9 grams (0.3oz)          |

## CAN OPENERS





# HYDRATION

## JERRY CAN 20 LITRE



A high-density plastic water carrier, with two different pouring holes



The smaller hole doubles as a breather for steady flow of water

### LARGE SCREW CAP & CHAIN



Strong and lightweight

|      |                                   |
|------|-----------------------------------|
| Code | CT019 (Jerry Can)<br>CT019C (Cap) |
|      | 2.2kg (4.8lbs)                    |
|      | 45x34x16cm (19x14x6")             |
|      | 20litres (42.2 pints)             |

## THERMAL FLASK

Keeps drinks hot for 6 hours or cold for 10 hours



|      |                        |
|------|------------------------|
| Code | CR083 ●<br>CR083B ●    |
| NATO | NSN-7350-99-449-0184 ● |
|      | 304 grams (10.7oz)     |
|      | 6.7x19.7cm (2.6x7.7")  |
|      | 0.4litres (0.7pints)   |

Stainless flask

Comes with screw top

Integrated pressure relief valve

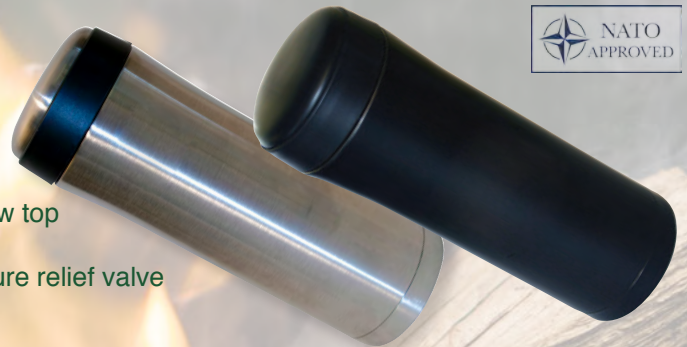

## REUSABLE DRINKING POUCH



Fits to universal tap adaptor

Pack of 2

Reusable

Ideal to store extra water with karabiner hanging clip

Flexible - folds flat when empty

Gusseted so will stand up

|      |                     |
|------|---------------------|
| Code | CR400               |
|      | 8.6 grams (0.3oz)   |
|      | 400 ml (0.75 pints) |

## STAINLESS INSULATED MUG

Excellent for a beverage on the move

Lockable drinking spout

Double skinned

Screw on lid

Stainless material

Robust

|      |                      |
|------|----------------------|
| Code | CR045                |
| NATO | NSN-7350-99-679-8140 |
|      | 259 grams (9.1oz)    |
|      | 400 ml (0.75 pints)  |





## JETSTREAM



Removable straps

Top and side opening

Zippered pocket

Strong: 500 denier multicam cordura

Easy to use mouth piece & cap

Attachments: 6 'D' rings and 4 side release buckles, to attach to the outside of payload day sack

Top and side double heavy duty zip



Contains the 3 litre reservoir shown below

Closed cell foam lined pouch for **insulation and protection**

**Lightweight shoulder straps are removable** so the system can be attached to larger pack yokes and makes it easier to fit into your rucksack

Polyamide fabric available in **multicam** or **black**

**Easy access double zip** extends down the pack and provides opening for the drinking tube over the shoulders or under the arm

|   |   |
|---|---|
| <b>Code</b>   | <b>CR802M</b> <br><b>CR802B</b>  |
|  | 280 grams (9.8oz)   |
|  | 3 litres (5 pints)  |

COOKING

HYGIENE

SURVIVAL

CAMO

CAMP

CLOTHING

MEDICAL

TOOLS

SPECIAL

## 3 LITRE REPLACEMENT RESERVOIR

Protective dust cover

Material: 0.4 mm TP

Slide-Seal™ Top - opens wide and seals tight

Durable, built for a lifetime of tough use, NoLeak™ Lifetime Guarantee

Surge™ Valve - silicone, 45 degree, high flow bite-valve with twist shut off

Hydrafusion™ Tube – ballistic TPU extrusion to insulate and protect

Inline filtration compatible

Plug-N-Play™ Connector - quick disconnect for convenient tube removal

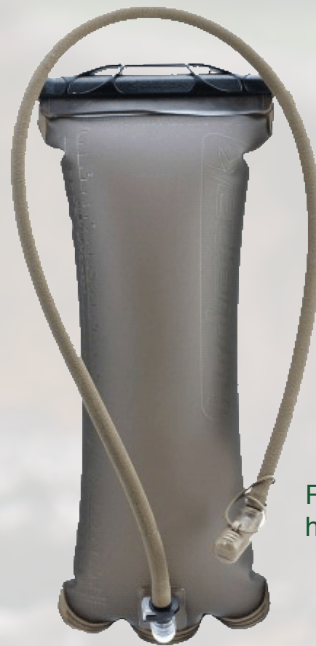



Large top opening for ease of cleaning

100% BPA and PVC Free

Quick removable connection

Can be frozen or filled with warm water (max temp 140°F / 60°C)

Reversible and anti-microbial to help prevent bacteria & mold

|  |                         |
|--|-------------------------|
| <b>Code</b>  | <b>CR816</b>            |
|  | 113 grams (4oz)         |
|  | 44x16.5cm (17.3x6.5")   |
|  | Capacity: 2.8Kg (100oz) |



# WASHING

## EXTRA LARGE CLEANSING WIPES



Hygienic cleansing towels

Soft re-sealable pack

Odourless

pH balanced

Works great prior to shaving

Great for in-field cleansing tasks where water is in short supply

Convenient for the removal of dirt, grease and camouflage cream from the skin.

25 wipes per pack

|   |                     |
|---|---------------------|
| Code  | CS610               |
|  | 14.5x8x3cm (6x3x1") |

Fine micro fibre towel, terry woven (looped pile)

A highly absorbent, super soft lightweight material

Packs small, and has the absorbency of a much larger towel

Absorbs over 5 times its own weight

Colour: Olive

## ULTRA LIGHT FIBRE TOWEL



|   |                   |
|---|-------------------|
| Code  | CJ003G            |
|  | 103 grams (3.6oz) |
|  | 40x80cm (16x32")  |

+44 (0)29 20 433 700

www.bcbin.com



## LIGHTWEIGHT FIELD MIRROR



Very tough, lightweight and durable

Stainless steel

Can be used for signalling in an emergency

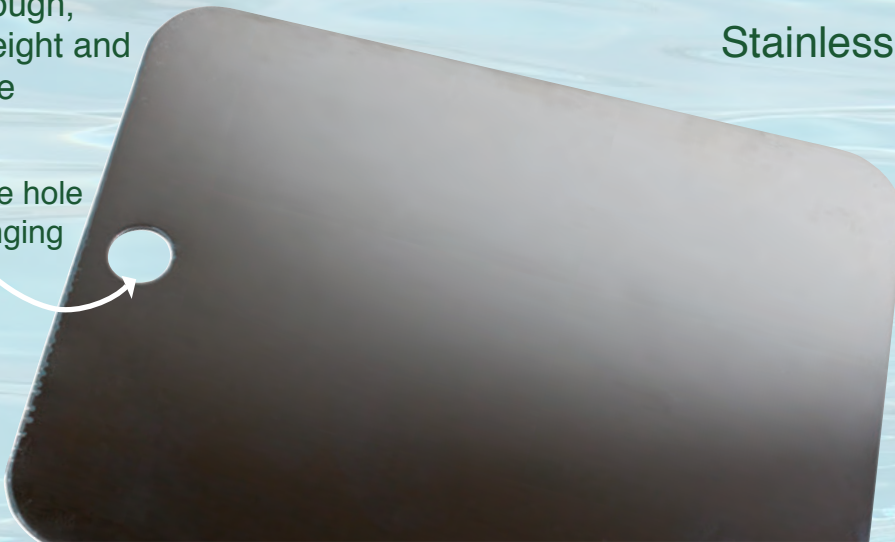
Use the hole for hanging the mirror



|   |                       |
|---|-----------------------|
| <b>Code</b>   | <b>CS614</b>          |
|  | 52 grams (1.8oz)      |
|  | 10.8x8.3cm (4.2x3.2") |

## TWIST RAZOR



Packs small

Durable & lightweight

Housed within a robust sheath

Twin blades readily available

Simply twist the base to reveal the razor

|   |                  |
|---|------------------|
| <b>Code</b>   | <b>CS613</b>     |
|  | 20 grams (0.7oz) |
|  | 8x2cm (3x1")     |



Four replacement blades included





## FOLDING TOOTH BRUSH

Folds neatly into the compact hygienic handle

Perfect for travelling



|   |   |
|---|---|
| <b>Code</b>   | <b>CS740</b>  |
|  | 20 grams (0.7OZ)                                    |
|  | Folded: 9.8X2cm (3.9X1")<br>Open: 16.5X2cm (6.5X1") |

Does not include toothpaste



# HYGIENE

Black vinyl absorbs solar heat, warming the 20 litre flexible reservoir



This portable light weight shower is easily packed and stored

Non-toxic durable PVC 700mm flexible tube and shower head

On/off spray setting

## SOLAR SHOWER





|   |   |
|---|---|
| <b>Code</b>   | <b>CR006</b>  |
|  | 278 grams (9.8oz)   |
|  | Folded:<br>35x18.5x6cm<br>(13.8x7.3x2.4")<br>Open:58x40x4cm<br>(22.8x15.7x1.6") |
|  | 20 litres (5 gallons)   |

## MANICURE SET

Handy manicure set contained within a small zipped wallet



Includes all tools necessary to keep you clean and neat

|   |  |
|---|--|
| <b>Code</b>   | <b>CS006</b>   |
|  | 124 grams<br>(4.4oz)   |
|  | Folded:<br>16x10.5cm<br>(6.2x4.1")<br>Open:<br>23x16cm<br>(9x6.2") |



## AQUA LOO/MEDICAL POUCH

A useful multicam pattern pouch complete with pockets, zipped compartments, handles, and a hanging clip. Ideal for medical supplies and/or toiletries



Cordura material

Numerous pockets

|   |                               |
|---|-------------------------------|
| <b>Code</b>   | CS003M 🌍                      |
|  | 104 grams (3.6oz)             |
|  | Open: 40x18x2cm (15.7x7x0.7") |

Contents not included

Both with multiple pockets and hanging clips

## COMBAT WASH BAG





Removable Mirror

3 x stuff pouches

1 x large mesh pocket

1 x large zippered pocket

1 x large zippered window pocket

|   |                          |
|---|--------------------------|
| <b>Code</b>   | CD416M 🌍                 |
|  | 200 grams                |
|  | Open: 67x25cm (26.8x10") |



# KITS

SPECIALLY SELECTED SURVIVAL KITS DESIGNED FOR YOUR ULTIMATE PROTECTION



20+  
ITEMS

## AIRBOURNE SURVIVAL KIT

Designed by the military for the military



A robust selection of components, sealed in a waterproof protection pouch, which has passed selection

Waterproof protection pouch allows easy access



|      |                      |
|------|----------------------|
| Code | CK028                |
| NATO | NSN-8465-99-354-0481 |
|      | 380 grams (13.5oz)   |
|      | 18x12x5cm (7x4.5x2") |

- Olive Green foil vacuum pouch • Black Nylon windowed pouch • Air-tight re-sealable bag • Green plastic survival bag • Mini-Compass • Mayday signal mirror • Tinder cards • Fine cord • Sail needles • Needle threader • Wire saw (wrist loops) • Fishing kit • Flexible tubing • Fireball Flint and Striker • Hacksaw striker • Brass wire • Suspender clips • Stainless steel multi-tool • Matches • Water bag • Water purifying tablets • Howler whistle

+44 (0)29 20 433 700

www.bcbin.com





# DISASTER GRAB BAG

We have developed the Disaster Grab Bag with everything you need packed inside to give you the very best chance of survival of the event of an emergency

40+  
ITEMS



25 Litre Daysack (Olive) • BCB Survival Instructions • Crusader Cooker MKII • FireFragon Fuel 6 Pack x2 • Fireball Flint & Striker Grand • Tinder Card (Packs 18 Strips / Pack) x2 • Wind & Waterproof Matches x25 • Nightlight x 4 • Collapsible Jerry Can (10 Litre) • Water Purification Tablets (2 x 50) • Salt Sachets x2 • Mess Tin • Plastic Spoon x4 • 2" Mayday Signal Mirror • Howler Whistle • Uni-Com Large Wind Up Torch •

Survival Bag - Orange x4 • Paracord • Lifesaver 2 First Aid Kit • Wet Wipes 25pack • Snapseal bags x10 • Toilet Paper x2 • Main Meals 300g x3 • All Day Breakfast Meal • Waterbottle & Mug

|      |                                      |
|------|--------------------------------------|
| Code | CK024                                |
|      | 3Kg (6.6lb)                          |
|      | 35 x 42 x 23cm<br>(13.7 x 16.5 x 9") |



20+  
ITEMS

# AIR CREW SURVIVAL PACK MK4



Successfully used in conflict and standard issue by Royal Air Force aircrew

This high specification kit is vacuum-sealed in olive foil packets and contained in a flexible olive bag

|      |                           |
|------|---------------------------|
| Code | CK420                     |
| NATO | NSN-8465-99-131-4124      |
|      | 450 grams<br>(16oz)       |
|      | 18x12x5cm<br>(7x4.7x1.9") |

• Water Purifying Tablets • Tinder • Small Tin • Water Carrier Condoms (2) • Fishing Kit • Flint & Striker, Fire Tablets • Wire Saw • Sewing Needles • Vinyl Tape • Sleeping Bag • Nylon Cord • Compass • Candle • Snare Wire • Suspender Clips • Razor Blade • Elastic Band • Instruction Sheet • Foil Blanket (Matt Olive)



# KITS



## HELICOPTER SURVIVAL KIT

A compact, modern survival kit specifically designed for helicopter crew and passengers in an emergency situation

60+  
ITEMS



|      |                                 |
|------|---------------------------------|
| Code | CK026A                          |
|      | 10.2Kg (22.5lb)                 |
|      | 31x39x29cm<br>(15.3x12.2x11.4") |

**Waterproof • Comprehensive • Long shelf life • Lightweight**

Lifesaver No3 First Aid Kit • Additional Adhesive Plasters x2 • Accident Evaluation x2 Form • Safety pins x6 • Hypothermia Foil Blanket x6 • Aircrew Pouch • Mini Grip Bag • FireDragon Fuel 6 Pack x4 • Folding Cooker • Mess Tin • Flint & Stricker x2 • Candle x2 • Cotton Wool Balls x6 • Tin Lid & Hanging Handle x2 • Fire Tinder x2 • Energy Bars x6 • Food Rations 500g • Water Purifying Tablets 100 Pack x 10 • Water Bags x10 • Fishing Kit x3 • Matches x2 • Large Mayday Signalling Mirror • Small Mayday Signalling Mirror x2 • Howler Whistle • Compass • Button Compass x2 • Waterproof Torch With Batteries x3 • Zoom Torch • Aircrew Survival Pamphlet • Razor Balde x3 • Sail Needle • Darning Needle • Mini Folding Knife • 24 in 1 Multitool • Lifeboat Axe • Knife x2 • Wire Saw x2 • Snare Wire x2 • Gaffer Tape x3 • Paracord (15m) x3 • Sewing Kit x 2 • Pencil x 2 • Fishing Line (2m) • Vinyl Tape 2 • Polar Survival Manual • Waterproof Survival Instructions x2 • BCB Waterproof Rucksack

+44 (0)29 20 433 700

www.bcbin.com





# SURVIVAL ESSENTIALS KIT

19  
ITEMS

A versatile and lightweight survival kit

A durable buckle secures the roll-top closure and acts as a grab handle



The **ultralight dry bag** keeps the weight down and helps keep your kit **safe and dry**

- Round Boot Laces • Led Micro Torch • Hypothermia Space Blanket • Hunter's Micro Tool • Fireball Flint And Striker
- White Nylon Cord • Nightlight • Sewing Kits • Fishing Kit • Wire Saw • Waterproof Matches C/W Striker • Duct Tape • Distress Whistle • BCB Survival Instructions • Cotton Wool Balls • 2" Mayday Signal Mirror • Ultralight Dry Bag (1 Litre)

|      |                                 |
|------|---------------------------------|
| Code | CK701                           |
|      | 404 grams (14.3oz)              |
|      | 13 x 165.5cm (5.1 x 6.2 x 2.1") |

SURVIVAL

COOKING

HYGIENE

SURVIVAL

CAMO

CAMP

CLOTHING

MEDICAL

TOOLS

SPECIAL



18  
ITEMS

# TREKKING ESSENTIALS KIT

• Ideal for temperate environments

• Can be left in the bottom of your bag at all times - just in case

• Easily packable and lightweight



- Round Boot Laces • Led Micro Torch • Emergency Poncho • Petroleum Jelly • Nightlight • Sewing Kit • Mini Folding Knife • Waterproof Matches C/W Striker • Duct Tape • Black Cable Tie • Distress Whistle • Waterproof Sterile Plasters • Wound Dressing • Zinc Oxide Tape • Paracord • Ultralight dry bag (1 litre)

|      |                            |
|------|----------------------------|
| Code | CK700                      |
|      | 236 grams (8.3oz)          |
|      | 13x16x5.5cm (5.1x6.2x2.1") |



# KITS



## ULTIMATE SURVIVAL KIT



24  
ITEMS

Packed into our **lightweight mini mess tin** with a **rubber seal** and **roll over clasps** - see further details on **page 19**

- Water Bag • Nylon Cord • Candle • Fireball Flint & Striker w/ Compass • Tinder • Fishing Kit • Mini Multi-Tool • Matches • Purification Tablets • Safety Pins • Single Edge Razor • Salt Sachets • Signal Mirror • Whistle • Snare Wire
- Wire Saw • Grip Lock Bag • Pencil • Survival Instructions • Sewing Kit •

|      |                                 |
|------|---------------------------------|
| Code | CK004A                          |
|      | 250 grams (8.8oz)               |
|      | 13 x 9.5 x 3cm (5.3 x 4 x 1.3") |



## COMBAT SURVIVAL KIT



20+  
ITEMS

Tin can be used to cook with

- Water Resistant Tin • Vinyl Tape • Knife • Book of Matches • Pencil
- Water Purification Tablets • Snare Wire • Fireball Flint & Striker w/ Compass • Fishing Kit • Distress Whistle • Sewing Kit • Safety Pins
- Wire Saw • Survival Instructions • Single Edged Razor Blades • White Nylon Cord (3ft) • Nightlight • White Cable Tie (140x3mm) • LED Micro Torch • Silicone Tubing •

|      |                               |
|------|-------------------------------|
| Code | CK015                         |
| NATO | NSN-8456-99-126-6980          |
|      | 195 grams (6.9oz)             |
|      | 11 x 8 x 2.8cm (4.5 x 3 x 1") |





# MILITARY SURVIVAL KIT



An upgraded vacuum-packed version of the combat survival tin



28 ITEMS

|      |                               |
|------|-------------------------------|
| Code | CK019                         |
| NATO | NSN-8645-99-147-7134          |
|      | 220 grams (7.7oz)             |
|      | 11 x 8 x 2.8cm (4.5 x 3 x 1") |

- Water Resistant Tin • Knife • Waterproof Matches • Pencil • Water Purification Tablets • Snare Wire • Nightlight • Fireball Flint & Striker w/ Compass • Fishing Kit • Distress Whistle • Sewing Kit • Safety Pins • Wire Saw • Signal Mirror • Tin Hanging Handle • Cotton Wool Tinder • Water Carrier Condoms • Single Edged Razors • Adhesive Plasters • Survival Instructions • Accident Evaluation Form • Nylon Cord • Black Tape (3m) • Fishing Kit • LED Micro Torch • Silicone Tubing • White Cable Tie •

# ESCAPE KIT



Personnel are more likely to succeed and survive with the right equipment and training. This is reflected in BCB's new escape kit.

Designed with modern operational experience this modular high specification kit is in a useful travel pouch and can also be broken down into different modules to be held on the person or in clothing.



25 ITEMS

- A hookit tool and luggage tag - to bypass latch locks • Combination padlock bypass tool • Lock Picks • Hook and spike bypass tool - to deactivate lock on handcuffs • GTFO wrist strap • Escape necklace - contains a handcuff key, R clip for manual dexterity, a shim and a striker bead • A go tube-designed to hold escape items in a concealable, lightweight, waterproof manner. • Extra long handcuff key • SAD tool - to escape from handcuffs and padlocks • High Tensile Steel Safety Pin • A firesteel - produces sparks of 3000 degrees Celsius • Ceramic razor blade • Mini lightsticks • Button compass • An Aide memoire • 72cm x 57cm Fabric escape map

|      |                            |
|------|----------------------------|
| Code | CK069                      |
|      | 212 grams (7.5oz)          |
|      | 21x11x3.5cm (8.2x4.3x1.3") |

Personnel requiring escape equipment will also likely require specific survival equipment. For customised escape kits please contact the expert: bob@bcbin.com

SURVIVAL

COOKING

HYGIENE

SURVIVAL

CAMO

CAMP

CLOTHING

MEDICAL

TOOLS

SPECIAL



# KITS



## WINTER DRIVER'S EMERGENCY PACK

Packed in a resealable long shelf life foil pouch

Foil Blanket • 8-Hour Lightsticks • Howler Whistle • Large Wind-Up Torch • Fleece Blanket • Handwarmers • Energy Bar • Round Boot Laces • Led Micro Torch • Emergency Poncho • Petroleum Jelly • Nightlight • Sewing Kits • Mini Folding Knife • Waterproof Matches C/W Striker • Duct Tape • Black Cable Tie • Distress Whistle • Waterproof Sterile • Plasters • Wound Dressing • Zinc Oxide Tape • Ultralight Dry Bag (Blue, 1 Litre) • Paracord •

|      |                                  |
|------|----------------------------------|
| Code | CK038                            |
|      | 806 grams (30.3oz)               |
|      | 28.5x28x14.5cm<br>(11.2x11x5.7") |

17  
ITEMS



41  
ITEMS

## HOME (72 HOUR) SURVIVAL KIT

This 41 piece survival kit contains everything you would need to keep you going for three whole days. The bucket doubles up as a toilet. **A must have for any survivalist.**

- FireDragon Folding Cooker • Insect Repellent • Book of Matches • 2" Mayday Signal Mirror • Hypothermia Space Blanket • Emergency Poncho • 24 In 1 Tool Kit • Oxford Note Pad & Pencil • Cleansing Wet Wipes • Oxford Note Pad & Pencil • Can Openers • Duct Tape •

Survival Bag • Paracord • Lifesaver 1 First Aid Kit • Firedragon Gel Fuel 250MI • Cut Resistant Gloves • Emergency Preparedness Guide • Bucket • Accident Evaluation Report • Single Edged Razor Blades • White Nylon Cord (1 Mtr) • Nightlight • Pencil • Gold Wires 12Ft • Fishing Kit • Wire Saw • Distress Whistle • Flint & Striker • Survival Instructions • Safety Pins • Grip Seal Bag • Sewing Kit • Polythene Bags • Water Purification Tablets • 12 LED Wind Up Lantern • White Cable Ties • LED Micro Torch • Silicone Tubing

|      |                        |
|------|------------------------|
| Code | CK047                  |
|      | 345 grams (12.1oz)     |
|      | 37.5x34.8 (14.7x13.7") |

Small, lightweight, and compact fishing kit, perfect for travelling light

Instructions included

Suitable for sea or freshwater fishing

- Line 36 Meters (118 Feet) • Winder
- Swivels • Feather Hooks • Lured Hook • Weights •

|      |                                |
|------|--------------------------------|
| Code | MM213                          |
|      | 64 grams (2.3oz)               |
|      | 8.5x13x1.5cm<br>(3.3x5.1x0.5") |

## SURVIVAL FISHING KIT



+44 (0)29 20 433 700



www.bcbin.com



Ideal for motorists, householders and remote workers

For when the weather takes a turn for the worse

- Cooking Tin • Fire Dragon Fuel Blocks X 2 • Led Torch • Folding Cooker • Distress Whistle
- Button Compass • Nightlight • Poncho With Hood • Hypothermia Blanket • Matches • Antiseptic Wipes • Drinking Pouch (400ml) • Karabiner • Pencil •

|   |                            |
|---|----------------------------|
| Code  | CK045                      |
|  | 452 grams (15.9oz)         |
|  | 20x16.5x8cm (7.8x6.4x3.1") |



## WINTER EMERGENCY KIT



## WATERPROOF SURVIVAL KIT



A waterproof roll-sealable pouch

Lightweight



Clear front

Watertight seal

Belt loops

Drawstring cord to loop over your neck

- Matches • Mini Folding Knife • Button Compass • Water Purification Tablets X 10 • Dry Bag • Micro Torch • Signalling Mirror • Duct Tape • Accident Evaluation Form • Razor Blades • Nylon Cord • Nightlight • Pencil • Sewing Kit • Gold Wire (12Ft) • Fishing Kit • Wire Saw • Distress Whistle • Fireball Flint & Striker • Survival Instructions • Safety Pins X 6 •

|   |                          |
|---|--------------------------|
| Code  | CK050                    |
|  | 198 grams (6.9oz)        |
|  | 12 x 19.5cm (4.7 x 7.6") |



Military specification fishing kit designed by NATO Forces.

Suitable for sea or freshwater fishing

Quick and easy to deploy multiple hooks

Compact but very comprehensive

- 30 metre Olive Green Fishing Line • 4x Fly Hooks • Hooks (4 X Medium, 8 X Small) with tied tracers to each of them • Split Shot (X 24) • Swivels (X 4) •

|  |                         |
|--|-------------------------|
| Code   | MM211                   |
| NATO   | NSN-4220-99-138-8693    |
|  | 65 grams (2.3oz)        |
|  | 19x6x2cm (7.4x2.4x0.8") |



## NATO LIFERAFT FISHING KIT





# KITS

These new packs are a great innovative design all of which contain:



**Water resistant zip opening • Clear fold-out inner sleeve to keep contents neat and easy to access • Belt loops • External clear pocket • Fluorescent Handle**

## S.E.R.E KIT





**The S.E.R.E (Survival. Evasion. Resistance. Escape) Kit** contains **29 essential items** This pouch can be easily stored in a daysack due to its compact design, perfect for all emergency situations.

- Signalling Mirror • Oxford Note Pad & Pencil • Folding Scissors • Single Edged Razor Blade • Cable Ties • White Nylon Cord 90cm (3ft) • Nightlight • Pencil • Sewing Kit • Gold Wire 3.5M (12ft) • Fishing Kit • Wire Saw • Distress Whistle • Fireball Flint & Striker • BCB Survival Instructions • Safety Pins • Clear Silicon Tubing 1M (3ft) • LED Micro Torch • FAK Pouch 4 • Duct Tape • Button Compass • 2 Tone Camo Cream •

|   |                          |
|---|--------------------------|
| Code  | <b>CK064</b>             |
|  | 390 grams                |
|  | 14x15x7cm (5.5x5.9x2.7") |

For the ultimate hunter, packed with tools for fire lighting, recording game and survival equipment. The multiple fold out compartments enables you to organise all your smaller hunting items

- Hypothermia Blanket • Oxford Note Pad & Pencil • Snapseal Bags • Single Edged Razor Blades • Button Compass • Cable Ties • White Nylon Cord 90cm (3ft) • Nightlight • Pencil • Sewing Kit • Gold Wire • 3.5M (12ft) • Fishing Kit • Wire Saw • Distress Whistle • Fireball Flint & Striker • BCB Survival Instructions • Safety Pins • Clear Silicon Tubing 1M (3ft) •



|   |                          |
|---|--------------------------|
| Code  | <b>CK067</b>             |
|  | 500 grams (17.6oz)       |
|  | 14x15x7cm (5.5x5.9x2.7") |

## THE HUNTER'S GRAB BAG



The ultimate survival kit for the elite explorer! Jam packed with tools, medical, fire lighting and emergency signalling items.

- Fireball Flint & Striker • 24 in 1 Multitool • Dog Tags • 3 in 1 Karabiner • Foil Blanket • Resucitator • Pencil • Sewing Kit • Wire Saw • Clear Silicon Tubing 1M (3ft) • White Nylon Cord 90cm (2.9ft) • Candle • White Cable Tie x 2 • Razor Blade x 2 • Fishing Kit • Gold Wire 3.5M (12ft) • LED Micro Torch • FAK Pouch 6 • Safety Pins x 12 • BCB Survival Instructions • Distress Whistle • Washproof Plasters x 20 • Scissors • Triangular bandage x 2 • Elastic Adhesive Bandage • Paraffin Gauze • Burn Bag • Medium Dressing x 2 • Large Dressing x2 • Cotton Gauze Swab • Conforming Bandages x6 • Lifesaver instructions leaflet •

|   |                           |
|---|---------------------------|
| Code  | <b>CK065</b>              |
|  | 830 grams (29.2oz)        |
|  | 26x14x7cm (10.2x5.5x2.7") |

## ELITE EXPLORER'S KIT







## TRAVEL BAG



Read the review:



"This Travel Bag pouch kit from the Cardiff manufacturer contains a load of useful stuff for the traveller – well it would do, wouldn't it"

- Joint-Forces.com



A handy carry-sized kit that contains all necessary travel items, so you'll never find yourself stuck without the essentials. The pockets and straps in the pouch allow you to add any extra personal items you don't want to leave home without.

- Folding Toothbrush • Twist Razor • Knife, Fork & Spoon Set • Folding Scissors
- Manicure Set • Cleansing Wipes • Snapseal Bags x 10 • Button Compass • Mosquito Head Net • Soap Box • Duct Tape • Plasters x 20 • LED Micro Torch • FAK Pouch 6 • Face Cloth (30x30cm)

|      |                           |
|------|---------------------------|
| Code | CK066                     |
|      | 982 grams (34.6oz)        |
|      | 26x14x7cm (10.2x5.5x2.7") |



## PREPPER'S PACK



|      |                           |
|------|---------------------------|
| Code | CK068                     |
|      | 830 grams (29.2oz)        |
|      | 26x14x7cm (10.2x5.5x2.7") |

A pack containing all items necessary for survival should you find yourself in an immediate survival situation.

Comes complete with:

- Survival Bag - Orange • Mayday Signalling Mirror 5cm (2") • Hypothermia Blanket • Jack Knife
- Single Edged Razor Blades • Cable Ties • White Nylon Cord 90cm (3ft) • Nightlight • Pencil • Sewing Kit
- Gold Wire 3.5M (12ft) • Fishing Kit • Wire Saw • Distress Whistle • Fireball Flint & Striker • BCB Survival Instructions • Safety Pins • Clear Silicon Tubing 1M (3ft) • LED Micro Torch • FAK Pouch 6 • Button Compass • Duct Tape •



This product contains age restricted items

COOKING

HYGIENE

SURVIVAL

CAMP

CAMP

CLOTHING

MEDICAL

TOOLS

SPECIAL



# PROTECTION





## FOIL HYPOTHERMIA BLANKET



The lightest and most compact blanket in our range. It assists in the retention of up to 90% radiant body heat

Lightweight foil sheet

Available in silver/silver or olive/silver

|   |   |
|---|---|
| Code  | RP041  / RK138  |
| NATO  | NSN-7210-99-991-0460  |
|   | 50 grams (1.7oz)  |
|  | 202x132cm (84x54")  |



## THERMAL FOIL PONCHO

Ideal to keep in your rucksack, vehicle or pocket just in case you get caught out

One size fits all



Integral hood helps maximize body heat retention

Radar reflective properties

Compact and lightweight

Pullover style provides maximum protection without restricting movement



|   |                   |
|---|-------------------|
| Code  | CL202             |
|  | 92 grams (3oz)    |
|  | 104x94cm (41x37") |

+44 (0)29 20 433 700

www.bcbin.com





## EMERGENCY SLEEPING BAG

A medium gauge, full size, polythene

Compact and lightweight it is ideal as a shield against the elements or as a waterproof outer layer for a sleeping bag

160 gauge (medium) polythene

Vacuum packed

|   |                    |
|---|--------------------|
| Code  | CL520              |
|  | 140 grams (5oz)    |
|  | 10x20x3cm (4x8x1") |



COOKING

HYGIENE

SURVIVAL

CAMP

CAMP

CLOTHING

MEDICAL

TOOLS

SPECIAL

## THERMAL PROTECTIVE AID

Ideal as a emergency hypothermia bag, or as an extra emergency cover to go over your sleeping bag



Ship's wheel approved

Over the head hood and zipper fronted

One size fits all

Compact and lightweight



|   |                     |
|---|---------------------|
| Code  | MF206D              |
|  | 345 grams (12.1oz)  |
|  | 20x30cm (7.8x11.8") |





## PRINTED SURVIVAL BAG

A highly visible, heavy duty, full sized poly bag printed with survival information covering fire making, navigation and shelter



500 gauge heavy duty poly-bag

Highly visible day-glo orange colour

|   |                      |
|---|----------------------|
| Code  | CL044                |
| NATO  | NSN-8465-99-684-4041 |
|  | 345 grams (12.1oz)   |
|  | 91.5x183cm (36x72")  |





# INFORMATION

## WATERPROOF NOTEBOOKS

Two tough, durable 50 page notebooks.

For outdoor, all-weather use.

The wood-based synthetic paper is **water resistant and environmentally friendly**, making it perfect for use in the field.

The notebook also benefits from a **tough plastic cover, elastic strap, pen loop and useful information printed on the inside covers.**





**Comes in two sizes:**

**A5** - Larger pages for big ideas! Includes a handy conversion chart and international dialling codes.

**Pocket sized** - Easy to carry around - you never know when you might need it

Includes rulers printed on the front cover

| Code  | CD454 (Large)            | CD453 (Small)           |
|---|--------------------------|-------------------------|
|  | 168 grams (5.9oz)        | 62 grams (2.2oz)        |
|  | 142 x 211mm (5.6 x 8.3") | 88 x 124mm (3.4 x 4.8") |



We can custom print these with your regiment/organisation name and logo with a minimum order of 5,000 pieces.

+44 (0)29 20 433 700

www.bcbin.com





An invaluable resource for emergency survival in extreme cold weather conditions

Packed full of useful information based on military training

70 pages

Small handy pocket size

|   |                     |
|---|---------------------|
| Code  | CD301               |
|  | 45 grams (1.6oz)    |
|  | 14.8 x 10.6 x 0.4cm |

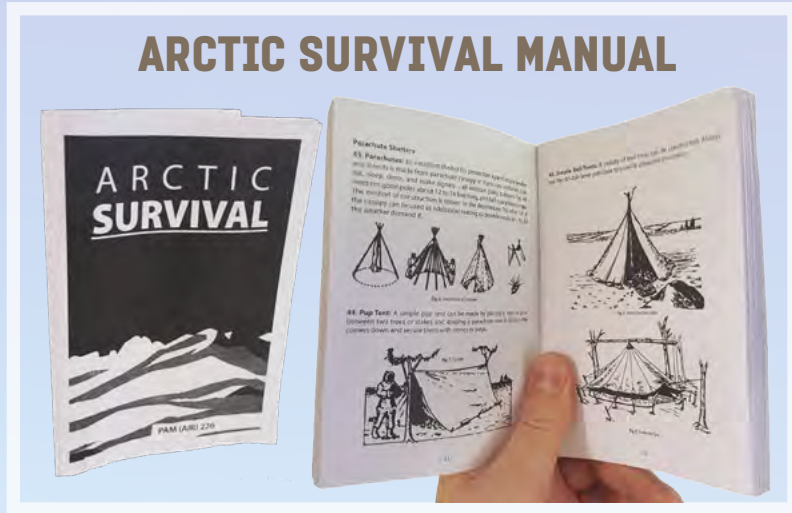

## ARCTIC SURVIVAL MANUAL

## AIRCREW SURVIVAL PAMPHLET

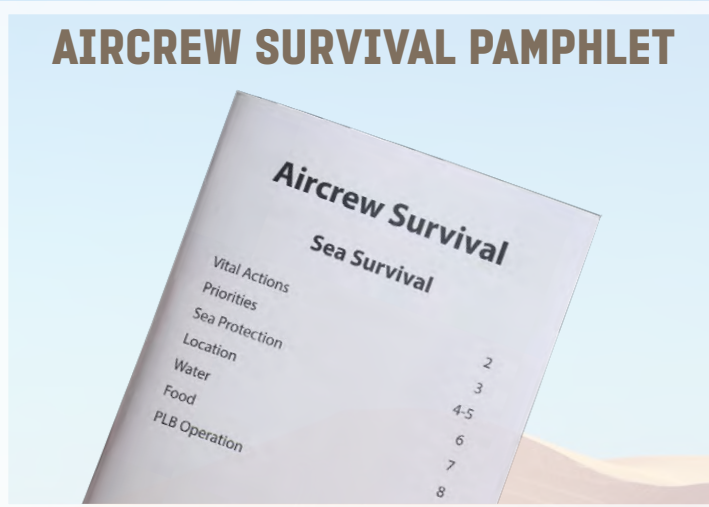



12 double sided water proof pages

Land survival instructions on front with sea survival on reverse

Instructions cover:

- Vital Actions • Windchill Chart
- Location • Desert
- Sea Protection • Priorities
- Freezing Injuries • Water
- Jungle • Protection
- Shelters • Food •
- PLB Operation

|   |                   |
|---|-------------------|
| Code  | CD557             |
|  | 30 grams (1.05oz) |
|  | 155 x 105 x 3mm   |



This definitive guide shows you how to survive in the wild, in any climate, on land or at sea, for campers, hikers, sailors and all of those interested in outdoor pursuits.

Preparing a shelter

How to make a fire in the cold and wind

How to find and cook food

Detailed instructions (with illustrations) on navigation, shelters, prepare signal fires and so much more

|   |                                      |
|---|--------------------------------------|
| Code  | CD441                                |
|  | 788 grams (27.7oz)                   |
|  | 21 x 14 x 3 cm<br>(8.2 x 5.5 x 1.1") |



## SAS SURVIVAL HANDBOOK



## ANTI-GLARE - EYE SHIELD



The eye shield Anti-glare protects the user's eyes from glare from the sun reflecting off sea or snow.

- ✓ Water resistant
- ✓ Mould resistant
- ✓ Fold flat



|   |                      |
|---|----------------------|
| Code  | CB207                |
| NATO  | NSN-8465-99-138-8051 |
|  | 10 grams (0.3oz)     |
|  | 210 x 100 x 4mm      |



# CAMOUFLAGE CREAM

EASY TO APPLY, COSMETIC GRADE CAMOUFLAGE PAINT

Available in  
four different  
colours:



**BLACK**

CL1493BK



**GREEN**

CL1493G



**BROWN**

CL1493BR



**TAN**

CL1493T

## CAMO CREAM TUBES

**SINGLE  
COLOURS**



**BCB'S FIRST SQUEEZY CAMOUFLAGE  
CREAM TUBES FOR EASY AND CLEAN  
APPLICATION**

+44 (0)29 20 433 700

www.bcbin.com



# "REVOLUTIONARY"

- JOINT-FORCES.COM

Read the review here:



CAMOUFLAGE



Easy to apply and remove

- Rich concentrated oil based formula
- Cosmetic high quality ingredients
- Non-irritant
- Sweat proof
- Long lasting
- British Quality



|  |             |
|--|-------------|
|  | 30g (1oz)   |
|  | 11cm (4.3") |

Available in a box of 28

COOKING

HYGIENE

SURVIVAL

CAMO

CAMP

CLOTHING

MEDICAL

TOOLS

SPECIAL



# CAMOUFLAGE STICKS



These convenient two-tone camo sticks create pattern disrupting stripes quickly and effectively without the need for a mirror

## 2 TONE CAMO STICKS

**TWO  
IN  
ONE**



- Quick drying
- Matte finish
- Easy application • Convenient size and shape

### Woodland



CL1480

### Desert



CL1480D

### Jungle



CL1480B

### Arctic

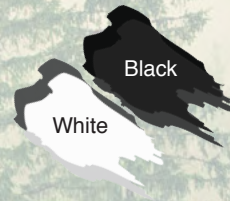

CL1480BW







Easily removed with mild soap or BCB Wet wipes (see page 23)



## Jungle



CL1481

## Woodland



CL1481B



## 2 TONE MINI

An even more compact and lightweight version of BCB's 2 tone camo sticks

## 2 Tone display box



## 2 Tone Mini display box



|                |                      |
|----------------|----------------------|
| <b>Product</b> | 2 Tone Camo Stick    |
| <b>NATO</b>    | NSN-6850-99-371-1878 |
|                | 60g (2oz)            |
|                | 9.3cm (3.7")         |

|                |                        |
|----------------|------------------------|
| <b>Product</b> | 2 Tone Mini Camo Stick |
| <b>NATO</b>    | NSN-6850-32-002-0754   |
|                | 30 grams (1oz)         |
|                | 6.3cm (2.5")           |

COOKING

HYGIENE

SURVIVAL

CAMO

CAMP

CLOTHING

MEDICAL

TOOLS

SPECIAL



# CAMOUFLAGE COMPACTS



**NEW  
SOFT  
FORMULA**



## Urban

| Softer   | Harder   |
|----------|----------|
| CL1482US | CL1482US |

## Woodland

| Softer   | Harder  |
|----------|---------|
| CL1482AS | CL1482A |

## Snow Terrain

| Softer  | Harder |
|---------|--------|
| CL1482S | N/A    |

## Multi-Terrain

| Softer   | Harder  |
|----------|---------|
| CL1482DS | CL1482D |

Tan and loam are also available to special order

Now in 2 different formulas • Non-irritant formula • No anti-oxidants added  
 • Not affected by rain • Fast drying • Halal acceptable • Aroma free • Shatter proof mirror • Deep dark colours • Highest European food and cosmetic grade ingredients •

### New short term softer formula

Easy on and off

Ideal for colder weather - does not freeze in colder climates unlike other camo creams

### Long term harder formula

For longer patrols / exercises

Ideal for warmer weather

Current NATO issue

Deep dark colours

Dries quickly to a matte finish

### Used by British and many NATO Forces



+44 (0)29 20 433 700

www.bcbin.com



Proven by British Military laboratory tests to “eliminate the NIR capability of skin”

N.B. Skin is a good reflector of NIR, meaning our camo cream won't give away your location



Available in attractive display box of 18

High sun protection

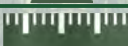

|   |                          |
|---|--------------------------|
| <b>NATO</b>   | NSN-6859-99-978-5980     |
|  | 70g (2.5oz)              |
|  | 8.5 x 6.5cm (3.3 x 2.6") |



COOKING

HYGIENE

SURVIVAL

CAMO

CAMP

CLOTHING

MEDICAL

TOOLS

SPECIAL



# CAMOUFLAGES NETS



NATO Issue



Lightweight



Infra Red Reflective

Reduces the thermal signature of hot objects

Quiet, rustle free, and matt anti-reflective printing

Suitable for all climatic conditions from -40°C to +70°C. Remains pliable in extreme temperature ranges

Non toxic, lightweight, waterproof garnish

Excellent colour fastness to U.V, water and abrasion resistance

Made to UK MoD specifications

Strong, durable and extremely robust

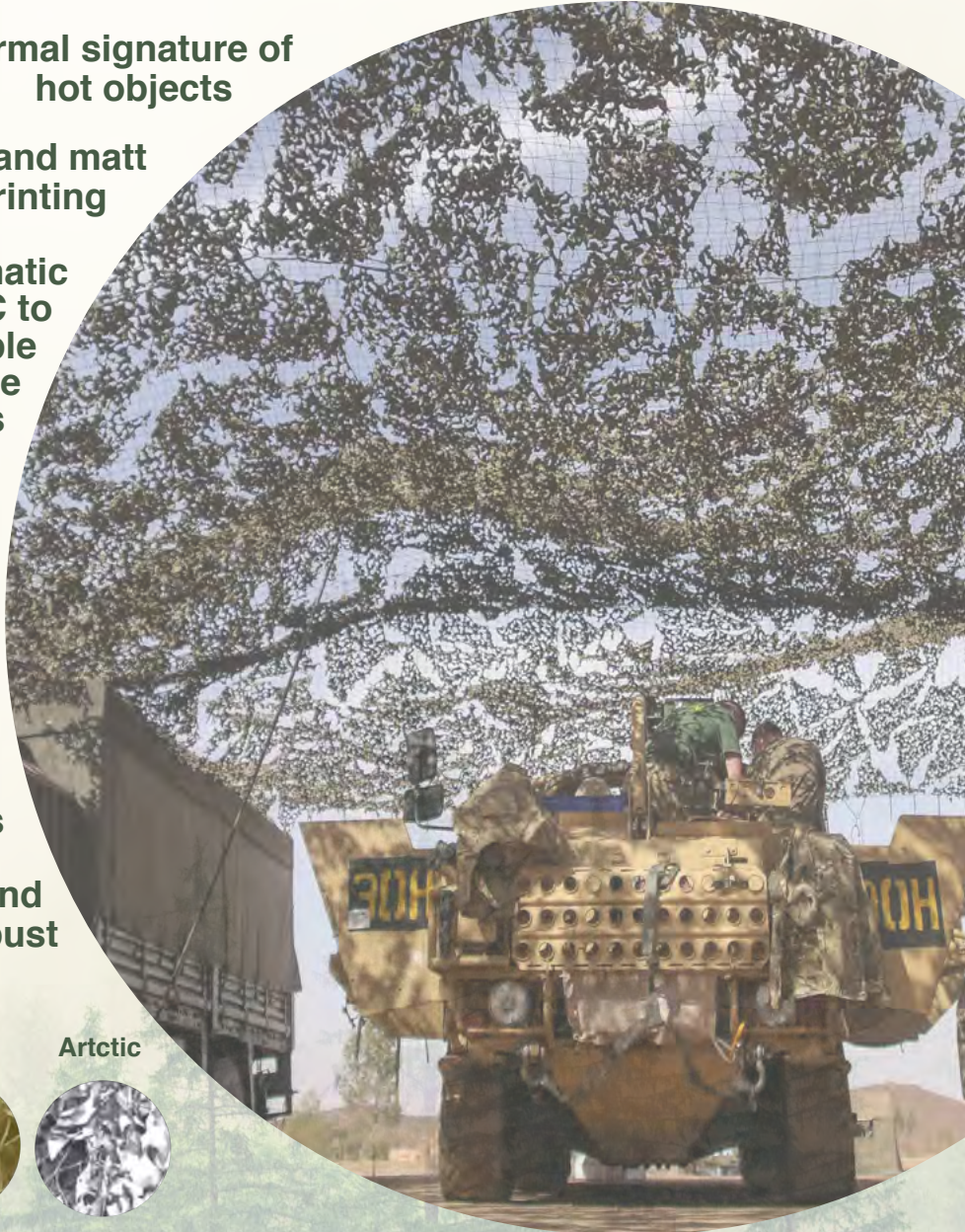

Woodland

Moorland/  
Mountain

Desert

Arctic

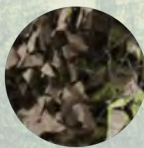

| Size | Metres      | Feet  | Woodland | Moorland/<br>Mountain | Desert | Arctic |
|------|-------------|-------|----------|-----------------------|--------|--------|
|      | 2.4 x 2.1   | 8x7   |          |                       |        |        |
|      | 4.5 x 4.5   | 15x 5 |          |                       |        |        |
|      | 7.5 x 7.5   | 25x25 |          |                       |        |        |
|      | 9 x 9       | 30x30 |          |                       |        |        |
|      | 11 x 11     | 36x36 |          |                       |        |        |
|      | 11.5 x 5.5  | 38x18 |          |                       |        |        |
|      | 11.5 x 11.5 | 38x38 |          |                       |        |        |
|      | 12 x 6      | 40x20 |          |                       |        |        |
|      | 12 x 12     | 40x40 |          |                       |        |        |
|      | 14 x 12     | 46x40 |          |                       |        |        |
|      | 16 x 16     | 53x53 |          |                       |        |        |
|      | 18 x 18     | 60x60 |          |                       |        |        |

Our camo nets are tested to and exceed the following UK MoD specifications:

- UK/SC/5094 Issue 14
- UK/SC/4830
- BS 3900
- BS 1006: 1990
- BS 3424: 1982
- BS EN ISO 2286: 1994
- BS EN ISO 2286-2
- BS EN ISO 1421: 1998

Watch our short video:



+44 (0)29 20 433 700

www.bcbin.com



## Standard Set Includes:

- 4' Pole x 4
- 8' Pole x 4
- Adaptor Sleeve x 8
- Spreader x 6
- Bag x 1
- Ground Stakes/Pegs x 24



**UK Made**



**BCB's camouflage nets can be made to your requirements. They come in various sizes and colours in order to camouflage almost anything.**

**Used by British Army and many other NATO members in South America, Asia and Middle East**

**Shower resistant**

**Available in: Woodland, Desert, Mountain/Moorland, or Arctic. Patterns, colours and sizes can be customized according to customer requirements.**

**Perimeter edge cord**

**Loops in each corner, and down long sides**

**U.V treated, mould and rot resistant**

**Strong**

BCB has been supplying the lightest camouflage systems to the UK MoD and to the international market for many decades. Over this time, BCB has built up a reputation as a market leader by delivering the best quality camouflaged goods on time and fit for purpose.

Additionally nets can be supplied in any size and may be joined together to cover larger and even awkward terrain.

Light, synthetic materials are used in the manufacturing process for your convenience when transporting and handling our nets. Nets may be used in alternative environments for your commercial or personal interests, for example trade shows, museums, stage sets... the possibilities are endless.



COOKING

HYGIENE

SURVIVAL

CAMO

CAMP

CLOTHING

MEDICAL

TOOLS

SPECIAL



# NETS

## INDIVIDUAL CAMOUFLAGE NET



**Lightweight and easy to carry**



Multispectral - protects the wearer in the **visual, infrared and thermal** spectrums.



**Camouflage net blocks thermal energy transmitted by the soldier**

Features a random pattern to allow the camouflage to blend in with the irregularities of nature

Patterns, colours and sizes can be customized according to customer requirements.

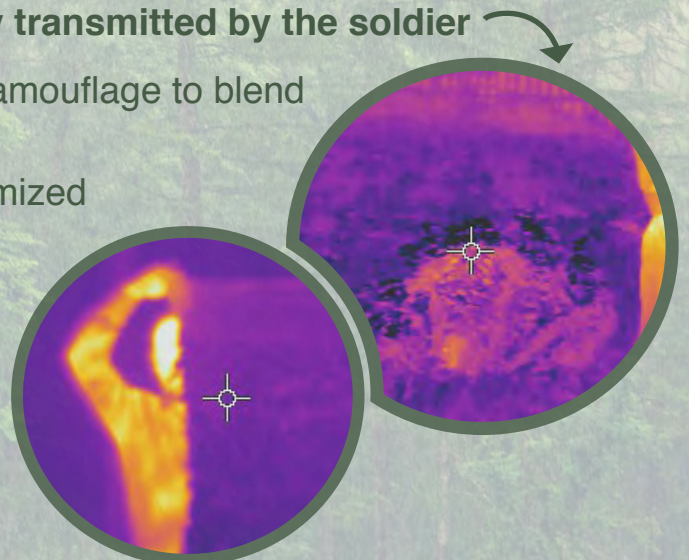

|   |   |
|---|---|
| <b>Code</b>   | Special Order - Please contact for more information |
|  | 1.33kg  |
|  | 2x2 metres (6ft 6"x6ft 6")                          |





## SNIPER SUIT



- Constructed from a comfortable, bug-proof netting, which is hand-washable
- Made from durable lightweight polyester fabrics
- Rot and mould proof, fire resistant
- 3D leaf-like foliage
- Quiet and rustle-free
- Pre-made, no assembly required
- **Compactable and strong**
- **Reversible colour combinations for added concealment**
- Designed to **break up your outline, disrupt your landscape and disguise objects**
- **Non-toxic environmentally friendly**
- The system offered is a complete and ready to wear ghillie suit comprising of a hood, long jacket and trousers, all in 3D disruptive woodland camo netting

|   |                           |
|---|---------------------------|
| Code  | RGKT01                    |
|    | 2.6kg (5.7lbs)            |
| (Chest)   | M/L 95-110cm (38-44")     |
|  | XL/XXL 115-130cm (46-52") |



## GHILLIE SUIT

- 4 pieces set - **hood, jacket, trousers and gun cover**
- **Elastic/drawstring** at waist, chest, neck and cuff
- **Easy snap closure** on jacket
- **Adjustable** chin strap in hood
- **Ultra lightweight**
- **Removable knee and elbow pads**

|   |                           |
|---|---------------------------|
| Code  | RGKT01A                   |
|  | 1.39kg (3.06lbs)          |
| (Chest)   | M/L 105-120cm (42-48")    |
|  | XL/XXL 120-140cm (48-56") |

Due to our continual product development, we reserve the right to alter or amend these products from what is shown, without prior notice.

COOKING

HYGIENE

SURVIVAL

CAMO

CAMP

CLOTHING

MEDICAL

TOOLS

SPECIAL



# SLEEP/SHELTER

## SHELTER SHEET

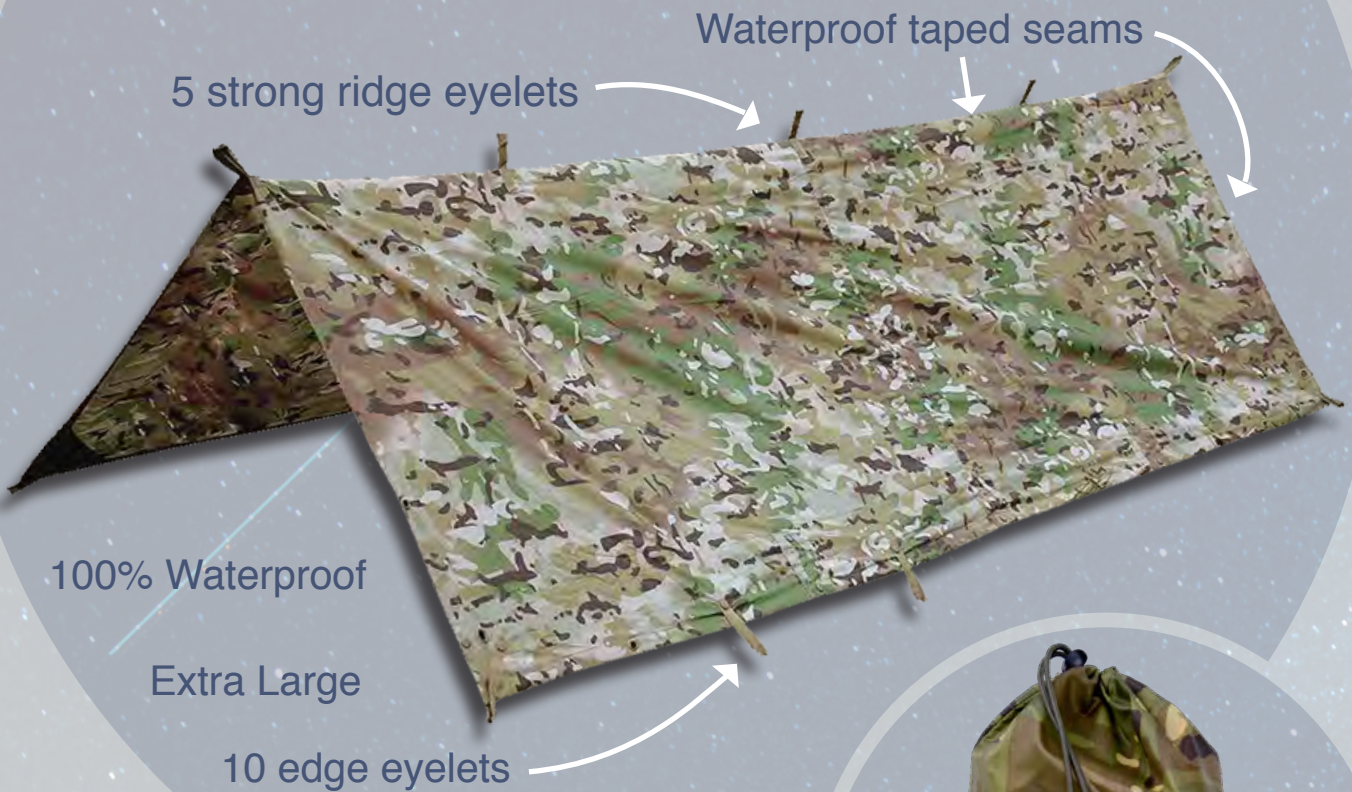

Can be slung between trees, tethered to vehicles, supported on bivouac poles, or folded double for use as a stretcher.

Multi Terrain Pattern (MTP)



Comes with a draw-cord closing system made of raided nylon, 9mm wide in light olive green.

Main material is silicone elastomer coated nylon.

Webbings are made of textile, nylon, single ply and the are 25mm & 55mm with a multi-terrain pattern. All ends are heat sealed.



|             |   |
|-------------|---|
| <b>Code</b> | CT125                                       |
| <b>NATO</b> | NSN 8105-99-213-3731                        |
|             | 2.6 metres x 2.16 metres<br>(8.5 ft x 7 ft) |

## STEEL PEGS

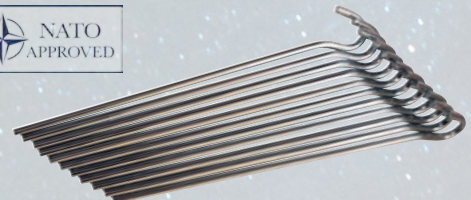

10 Steel pegs for use with tents and bashas

|             |                      |
|-------------|----------------------|
| <b>Code</b> | CT017                |
| <b>NATO</b> | NSN 8415-99-213-3730 |
|             | 260 grams (9.5oz)    |
|             | 18cm (7")            |

+44 (0)29 20 433 700

www.bcbin.com







## FOX® LIGHTWEIGHT WATERPROOF 3 PART SLEEPING SYSTEM

### 1 COVER (BASHA)

A lightweight robust shelter sheet forming the third element of the fox sleeping system. Features a fully tape-seamed hem and reinforced, suspension points.



Compact and lightweight PU coated Ripstop Nylon Woodland camo print  
16 x suspension points  
NATO approved  
2 mosquito net suspension points

|   |   |
|---|---|
| <b>Code</b>   | CT047 <br>CT047G  |
|  | 630 grams<br>(22.2oz)   |
|  | 257x214cm   |

### 2 MOSQUITO NET



Fox® Jungle Mosquito Net

A rugged, close weave polyester mosquito net.

The net is clipped to fabric loops underneath the basha and via elasticated hooks underneath the hammock.



This shapes the net, pulling the mesh walls away from the body and prevents the net from sagging and allowing insects to enter.

|   |   |
|---|---|
| <b>Code</b>   | CT433  |
|  | 480 grams<br>(16.9oz)   |
|  | 225 x 120<br>x 105*cm<br>(88 x 47<br>x 41**)  |

### 3 HAMMOCK



Fox® Jungle Hammock

A generously sized, parachute grade, ripstop-nylon hammock.



Extremely hard wearing and comfortable it provides protection against the elements and biting insects.

Extremely strong.

|   |   |
|---|---|
| <b>Code</b>   | CT430  |
|  | 590 grams<br>(20.8oz)   |
|  | 270 x 140*cm<br>(106 x 55**)  |

\*Measurements are approximate

Complete Fox System 3 in 1: **1 + 2 + 3**

The complete system includes hammock, mosquito

|   |              |
|---|--------------|
| <b>Code</b>   | CT434        |
|  | 1.7kg (60oz) |



# SLEEPING

## SELF INFLATING MAT



Extra thick foam makes it ideal for use on stoney terrain

**Brass inflation valve.** If required the mat's inflation can be topped up orally via the valve

Fastening straps supplied

Quick & easy to assemble



**Top:** pvc with a non slip taffeta coating  
**Base:** pvc with a non-slip polyester coating

**Load limit:** 200kg maximum stuff bag

**Top colour:** dark green

**Base colour:** grey



**Foam:** polyurethane 24kg/m3

|   |   |
|---|---|
| <b>Code</b>   | CT650D  |
|  | 1.39kg (3.06lb)   |
|  | Packed: 32 (H) x 19cm (W)<br>Open: 190 (L) x 60 (W) x 2.5cm (H) |

### Mummy shaped

Materials (top): 210t diamond ripstop polyester coated pvc orange

Materials (base): doobby polyester coating pvc + foam

|   |   |
|---|---|
| <b>Code</b>   | CT649   |
|  | 770 grams   |
|  | Inflated: 180x50x3CM<br>(70.8x19.6x1.1")<br>Packed: 16x26CM (6.2x10.2") |

## INFLATABLE AIRBED



## FOLDING SLEEPING MAT

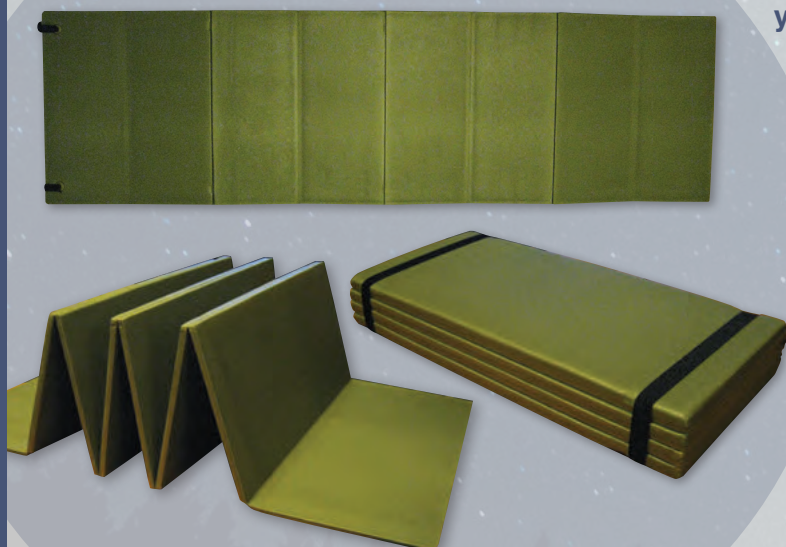

This new foldable sleeping mat fits inside your rucksack

Combines **durability** and **non absorbent** qualities as well as **insulation** and **compression resistant**

Can be used as a **sit mat** when folded

It can be used fully unfolded or in a **number of combinations**

Material complies with **UK military standard**

|  |  |
|--|--|
| <b>Code</b>  | CT650B   |
|  | 350 grams  |
|  | Open: 52x180x0.8cm (20.5x70.9x0.3")<br>Folded: 52x6x23cm (20.5x2.4x9") |



## MODULAR SLEEPING BAG SYSTEM



The modular sleeping system includes **two sleeping bags**:  
 One for warmer climates (+12°C)  
 One for temperate climates (-2°C - 6°C)

For cold weather, the two sleeping bags can be combined for additional warmth

100% Reinforced synthetic Rip Stop

|             |                         |
|-------------|-------------------------|
| <b>Code</b> | CT128                   |
|             | 3.2kg (7lbs)            |
|             | 80 x 220cm (31.5 x 86") |

## OLIF RANGE SLEEPING BAG



Stays warm in -35°C

|             |                                    |
|-------------|------------------------------------|
| <b>Code</b> | Olif SZ: CT1210<br>Olif 35: CT1200 |
|             | 2.4kg                              |
|             | 220cm x 75cm                       |

The Olif is a top of the range sleeping bag designed to withstand extreme climates.

Ranging from -14°C to -35°C, the Olif is a must have to ensure adequate protection against the outdoors.

Both variants are also available in a bright orange colour.

|                   | Olif Sub-Zero                             | Olif -35                                  |
|-------------------|---|---|
| <b>Colour</b>     | Olive or Orange                           | Olive or Orange                           |
| <b>Filling</b>    | 300g/m <sup>2</sup> synthetic micro-fibre | 400g/m <sup>2</sup> synthetic micro-fibre |
| <b>Shape</b>      | Mummy shape with hood                     | Mummy shape with hood                     |
| <b>Outer</b>      | 70D Ripstop nylon                         | 70D Ripstop nylon                         |
| <b>Lining</b>     | 40D Nylon                                 | 40D Nylon                                 |
| <b>Tested to:</b> | EN ISO 23537-1:2016                       | EN ISO 23537-1:2016                       |
| <b>Extreme</b>    | -24°C                                     | -35°C                                     |
| <b>Low</b>        | -7°C                                      | -14°C                                     |
| <b>Comfort</b>    | 0°C                                       | -7°C                                      |

## MINI HAMMOCK

Extremely strong 2.5cm (1") mesh

Includes 2m (6ft) rope

Lightweight

Holds up to 120kg

|             |                  |
|-------------|------------------|
| <b>Code</b> | CT430C           |
|             | 320 grams (11oz) |
|             | 270cm (106")     |



COOKING

HYGIENE

SURVIVAL

CAMO

CAMP

CLOTHING

MEDICAL

TOOLS

SPECIAL



# SLEEPING

Lightweight and space efficient

Capable of resisting excessive absorption of liquids

Comfortable when used in all climatic conditions

PU cover



Ease of packing with 5 folding sections

Hygienic and washable

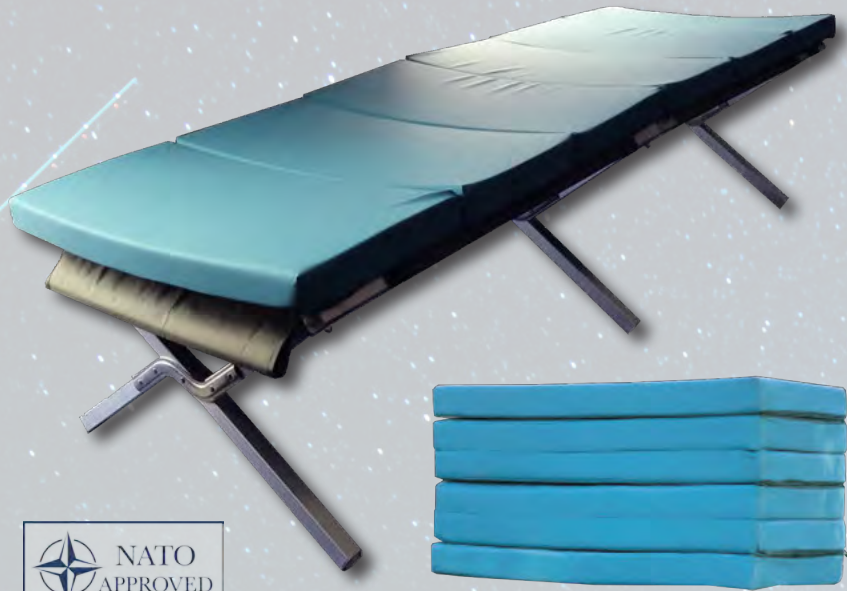
## FOLDING MATTRESS



Manufactured to ISO 9001/2008  
 Tested to conform to: BS7177:2008 + A1 2011  
 domestic use, BS EN 597-1: 1995  
 Resistance to ignition with source

|  |   |
|--|---|
| <b>Code</b>  | FF007   |
| <b>NATO</b>  | NSN- 7210-99-695-4361   |
|  | 3.2kg (7.05 lbs)  |
|  | Packed: 64(L) x 33(W) x 31.5cm(H)<br>Unpacked: 200(L) x 64(W) x 50cm(H) |

## X-LARGE FOLDING BED





Over 2 metres long



Extra strong **specially designed for large people**. The fabric is treated so that it won't stick or melt in hot temperatures, or make any noise when in use.

Stable on moderately uneven ground



Fabric: 100% **fire resistant** polyester  
 Frame: **Aluminium**, anti-oxidation  
 Frame thickness 1.4mm  
 Thickness 2.5mm  
 Weight bearing capacity 150KG  
 Carry bag material 600D polyester  
 Tested to conform to: EN 581-1: 2006,  
 EN 581-2: 2009

|   |                      |
|---|----------------------|
| <b>Code</b>   | FF006NL              |
| <b>NATO</b>   | NSN-7105-99-669-8141 |
|  | 8.5kg (18.7 lbs)     |
|  | 208 x 68 x 45CM      |



Current NATO issue bed  
 Strong and robust  
 Military approved and tested  
 Compatible with camp-cot mosquito net  
 Easy and quick to deploy  
 Cover 500D polyester material  
 Compact when folded  
 Manufactured to ISO 9001/2008  
 Tested to conform to: EN 581-1: 2006, EN 581-2: 2009



|   |  |
|---|--|
| <b>Code</b>   | FF006  |
| <b>NATO</b>   | NSN- 7105-99-669-8141  |
|  | 7.5kg (16.5 lbs)   |
|  | Folded: 97cm(L)x18cm(W)x20cm(H)<br>Unpacked:196cm(L)x76cm(W)x44cm(H) |

## CAMP COT MOSQUITO NET

Net top can **hang a torch, book storage bag** and other **personal items**

2 x long 9 section elasticated strong poles manufactured to ISO 9001/2008

75D nylon fabric, 21g/m 156 hole/inch

A **compact robust close weave polyester mosquito net**

Easy and quiet open double zips

Supported by two aluminium poles, which create a dome effect to ensure the mesh is pulled away from the body and **prevents the net from sagging**

Products material all match WHO standard

**Permethrin impregnated**

**Easy setup** - about 8 minutes

Fixes onto **camp cot folding bed**

**Noiseless material**

**Waterproof ground sheet**

**Two door** (side entry)

|   |   |
|---|---|
| <b>Code</b>   | FF008   |
| <b>NATO</b>   | NSN-7210-99-731-1754                                      |
|  | 220cm (L) x 80cm (W) x 110cm (H)<br>(86.6 x 31.5 x 43.3") |



COOKING

HYGIENE

SURVIVAL

CAMO

CAMP

CLOTHING

MEDICAL

TOOLS

SPECIAL



# FOUR SEASONS TENT - 6 PERSON

The BCB Four Seasons is an **ultra reliable, feature packed freestanding tent** capable of four-season use while backpacking, training and travelling

6 person

The four pole construction makes it **stable in high winds** and easy to pitch on uneven terrain.

Includes **extra pole** segment for repairs

20 pegs included

4 strong aluminium poles for easy set up



Available in a range of colours subject to MOQ

Wide strong snow skirt

60 cm valance for use in different conditions

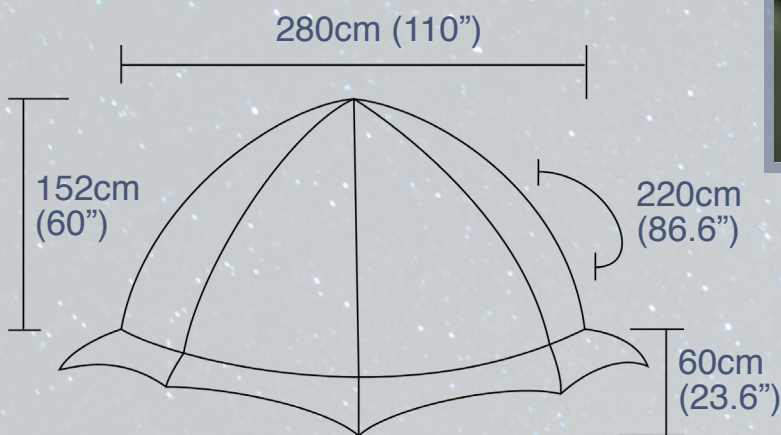
Ventilation holes



|   |  |
|---|--|
| <b>Code</b>   | CT670G   |
|  | 7.5kg (16.5lbs)  |
|  | Packed: 68x27x23cm (26x10x9")                            |
|   | Open: 280(W) x 220(D) x 152cm(H)<br>(110" x 86.6" x 60") |



## INFLATABLE PILLOW



This handy travel pillow packs up **small and is quick to inflate.**

Made of PVC covered with **comfortable Swedish polyester.**

The bottom is **anti-slip** polyester.

|   |                  |
|---|------------------|
| <b>Code</b>   | CB601            |
|  | 60 grams (2.1oz) |
|  | 32x22x10cm       |



## FOLDING STOOL



This small lightweight stool is strong and robust

Frame work: 22.3mm diameter, steel

Seated pad pvc:  
43.5 Cm (l) x 27.5Cm (w) x 0.55Mm

Wipe clean material

Fire retardant

Olive green

Rubber feet for extra grip

Manufactured to ISO 9001/2008  
Tested to conform to: BS EN 581, BS EN 16139

|             |   |
|-------------|---|
| <b>Code</b> | FF004   |
| <b>NATO</b> | NSN- 7105-99-912-2211   |
|             | 60g (2oz)   |
|             | Folded: 41.5cm(W)x5cm(D)x61cm(H)<br>Unpacked: 41.5cm(W)x44cm(D)x44cm(H) |

Stable, flame retardant and anti-liquid absorbent

Includes drink holder

It avoids point loading, as each leg has a strong wide foot on the bottom

Very comfortable with padded arms

This product is manufactured from 600 x 300D/PVC + high quality waterproof polyester wadding inside.

Tested to conform to: BS EN 581 - Pt 1 BS EN 16139 - Furniture Strengths, Durability and Safety Level 1 and Level 2

|             |                                      |
|-------------|--------------------------------------|
| <b>Code</b> | CT984                                |
|             | 4.9kg (10.8lbs)                      |
|             | 64 x 63 x 95cm (25.2 x 24.8 x 37.4") |

## FOLDING CHAIR



Robust, lightweight and space efficient seating system

Will fit comfortably and interoperable with the folding table and field desks

Strong HDPE plastic panel

Powder coating finished steel frame: 28 x 1.0mm

Stackable and can easily carried by one person

Plastic feet for extra grip and stability  
Manufactured to ISO 9001/2008

|             |  |
|-------------|--|
| <b>Code</b> | FF009  |
| <b>NATO</b> | NSN- 7105-99-729-8853  |
|             | 5kg (11lbs)  |
|             | Packed: 17 x 47 x 115cm (6.7 x 18.5 x 45")<br>Unpacked: 52 x 47 x 89cm (20.5 x 18.4 x 35") |

## FOLDING CHAIR WITH ARMS



Easy to fold/unfold

COOKING

HYGIENE

SURVIVAL

CAMO

CAMP

CLOTHING

MEDICAL

TOOLS

SPECIAL



# FIELD DESKS

## DEPLOYABLE DESK<sup>2</sup> (DD<sup>2</sup>)



Available  
in either  
sand or  
olive

This field desk is simple, **highly practical** and **functional**.

You can add a **removable security screen**.

**The DD<sup>2</sup> is larger and quicker to deploy than the Commander's Field Desk**

**Robust, lightweight and folds away for storage or transport**



Simple and intuitive to deploy (from storage/transportation state) in less than 2 minutes by untrained personnel

Excellent for storing papers, whilst allowing them to be hidden from view for privacy when needed

Easy and quick to deploy & fold up. Simply unclick, fold out the two flaps & rotate on the central pivot, then fold down the legs

- Strong, lightweight, drop down legs.
- Smooth flat tabletop when opened
- Two large drawers for file dividers & files, two lockable smaller drawers
- Lightweight: can easily be carried by two people or manoeuvred on its wheels by one person
- A folding privacy screen (available as an optional extra) can quickly & easily be slotted into the front, rear and/or sides to improve secrecy.
- Two plugs or computer extension sockets (not supplied) can be quickly & easily attached under the two side flaps, so they are easily accessible, while out of sight
- Supplied with two BCB folding stools inside



|   |   |  |
|---|---|--|
| Code  | FF014 <span style="color: orange;">●</span>   | FF013 <span style="color: green;">●</span> |
|  | 54kg (119lbs)   |  |
|  | Open: 214.5 x 74.7 x 81.5cm (84.5 x 29.4 x 32")<br>Closed: 68.2 x 74.7 x 81.5cm (26.8 x 29.4 x 32") |  |



## COMMANDER'S FIELD DESK (CFD)

Includes five spacious drawers and large surface area

Foldable design makes transport practical and space-saving. It is then easy to fold open into place

NATO approved



## PRIVACY SCREEN

Simply attach the privacy screen for a fully-functional, discreet desk.

PVC coated on both sides

Resistant to fire damage and the spread of flames

Fits into a drawstring bag and can be placed into the draw in the of the Field Desk.



Perfect for use with our field chairs - see page 58

| Code | FF002 - Commander's Field Desk  | FF003 - Privacy Screen                |
|------|---|---------------------------------------|
|      | Unfolded: 200 x 59 x 73cm (78 x 23 x 28")<br>Folded: 70 x 59 x 73cm (27 x 23 x 28") | 1.6kg (56oz)                          |
|      | 44kg (97lbs)  | Unfolded: 193x45.5x1cm (76x17.9x0.4") |

COOKING

HYGIENE

SURVIVAL

CAMO

CAMP

CLOTHING

MEDICAL

TOOLS

SPECIAL



# FURNITURE



Rubber feet  
 Strong - holds 4+ people  
 Robust, lightweight and  
 space efficient

Can be used independently and in  
 conjunction with other field furniture  
 as defined in this specification

Easy to deploy  
 Suitable to be carried by one  
 person

Tested to conform to: BS EN 581,  
 BS EN 16139

Manufactured to ISO 9001/2008

|   |                                 |
|---|---------------------------------|
| <b>Code</b>   | FF001                           |
| <b>NATO</b>   | NSN- 7210-99-731-1754           |
|  | 6.8kg (14.9lbs)                 |
|  | Unpacked: (L)220x(W)80x(H)110cm |



## GENERAL SERVICES BENCH



## FOLDING TABLE





A strong and durable table with reinforced  
 foldable steel legs.

Toughened plastic top.

HDPE plastic panel thickness: 4.0cm  
 Powder coating finished steel Frame:  
 28 x 1.00mm

Tested to conform to: BS EN 581 - part 1  
 and 3 level  
 BS EN 15372 - level 2 and 3

|   |  |
|---|--|
| <b>Code</b>   | FF012  |
| <b>NATO</b>   | NSN-7110-99-555-5662   |
|  | 13kg   |
|  | Overall size: 184(L)x76(W)x73cm(H)<br>Packing size: 186x77x4.5cm |

This cooler has an excellent refrigeration and freezing  
 power.

Extremely efficient and silent

Robust

Digital temperature display

Easy to transport: Carrying handle

Solar power running • WIFI application LED lighting •



USB port

Storage volume: 46 Litres

**Freezing functioning up to -22°C**

Power supply: 220V AC/ On battery: 12/24V

Colour: Grey

|   |                        |
|---|------------------------|
| <b>Code</b>   | CA209                  |
|  | 46 litres (80.9 pints) |
|  | 20.4kg (45lbs)         |
|  | 72.5x47x45.5cm         |



## COOLER



A robust, lightweight and easy to use solar shower that holds 20 litres of water.

Includes a temperature gauge, 1 metre long hose, reinforced handle and front pocket.

Easy to maintain and store due to its compact design.

Crease resistant waterproof material, in olive or dark green.

|   |                                   |
|---|-----------------------------------|
| <b>Code</b>   | CT1267                            |
|  | 460 grams (16.2oz)                |
|  | 33 x 12 x 60cm (13 x 4.7 x 23.6") |

## SOLAR SHOWER 20 LITRE





A sheltered wc or shower with pockets and a door.

It is quick to mount, and easy to clean and maintain.

Robust, compact and lightweight design.

Waterproof (HH1500) and fire resistant (EN-5912)

Crease and pinch resistant

|   |  |
|---|--|
| <b>Code</b>   | CT126  |
|  | 3.3kg (7.3lbs)   |
|  | Unfolded: 1.3 x 1.3 x 2.1 metres (51 x 51 x 82")<br>Folded: 55x13x12cm (21 x 5.1 x 0.8") |

## INDIVIDUAL SHELTER SHOWER/WC



## HANGING COLLAPSIBLE WARDROBE

A lightweight and space efficient personal administration and storage aid used by tri-service field force units

Simple and intuitive to deploy



Capable of being threaded onto the tent frame

The ITC tent pole is 5cm (2") in diameter

**Resistant to fire damage and the spread of flames**

Distributed load:  
20kg

**Hangs from your tent pole**

|   |  |
|---|--|
| <b>Code</b>   | FF005  |
| <b>NATO</b>   | NSN-7105-99-495-1124   |
|  | 4.9kg (10.8lbs)  |
|  | Packed: 30x30x15cm (11.8x11.8x5.9")<br>Unpacked: 30x30x120cm (11.8x11.8x47.2") |



COOKING

HYGIENE

SURVIVAL

CAMO

CAMP

CLOTHING

MEDICAL

TOOLS

SPECIAL



# SANDBAGGER

For flood defences, building and reinforcing defensive positions, quickly and easily. The time saved could save lives.

Sandbags (and lots of them) are essential for protection against blast, bullets and floods. When you need them you want them quickly. The BCB Sandbagger will help you produce all you need, right where you need them.

“Normally filling sandbags is a tiring two-person job with one of the two having to hold each bag as it filled.

But the Sandbagger - which holds sandbags in a metal frame under a large hopper - allows one person to fill two bags at the same time”

- Wales Online



Fills more than twice as many sandbags per hour

This sandbagger will pay for itself in less than two days



Can be used with synthetic or hessian types of sandbags

Can be erected in less than one minute

Can be used with dry soil, salt or aggregates

Quick fill and removal of sandbags

Plastic coated finish

Virtually maintenance free

Easy to use - little training needed

Few moving parts

Easily portable and stackable

Rust Proof

+44 (0)29 20 433 700

www.bcb.in.com



"The BCB sandbag filter is well-engineered and performed well during trials assessment.

**This would be the preferred equipment if a sandbag filler is required"**

- Extracts from the British Royal Engineers Report 2008 on the BCB Sand Bagger

Assuming a soldiers salary is \$20 per hour...

|  | By Hand            | Using the Sand Bagger |
|--|--------------------|-----------------------|
| Time to fill 100 sand bags:              | 182 minutes        | 88 minutes            |
| Labour Cost to fill 100 sand bags:       | \$60.66 (2 people) | \$29.33 (1 person)    |
| Labour Cost to fill 5 million sand bags: | £3,033,000.00      | \$1,466,500.00        |

**Therefore: Saving per year using the Sand Bagger: \$1,566,500.00 (or 50%)**

Time taken to recoup outlay on the sandbagger is **11 and a half hours**

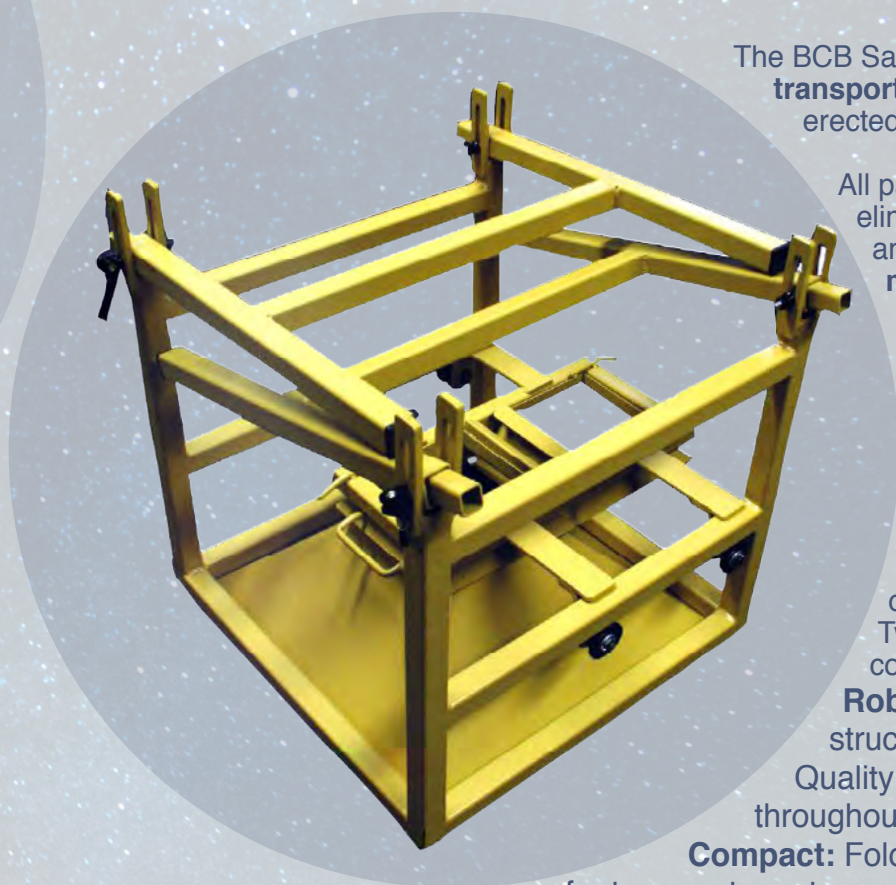

The BCB Sandbagger **collapses** for easy transportation and storage and can be erected in seconds.

All parts remain attached which eliminates the possibility of loss and the machine is **completely maintenance free**.

With the saving in labour cost the sandbagger will pay for itself in the first 11½ hours of use.

The wide mouth hopper combined with the unique twin bag slide system allows either: One person to fill 2 bags at once, or:

Two people to fill sandbags continuously

**Robust:** The design loads structurally the strongest points.

Quality: High quality steel used throughout.

**Compact:** Folding legs reduces its size by half



for transport, or storage. Eight per Euro pallet 120cm

high. No detachable components to lose. Light enough for one person to carry.

**Flexible:** The feet allow it to be used in a soft, dry sand. It can be used with dry earth or shale. Its strength and its large hopper mean it can also be filled by a small mechanical digger

## SANDBAGS



|   |   |
|---|---|
| Code  | CM999   |
|  | 21.21kg (46.7 lbs)  |
|  | Folded: 51 x 51.5 x 54.5cm (20 x 20.27 x 21.4")<br>Assembled: 51 x 51.5 x 92.5 (20 x 20.27 x 36.4") |

**Hessian Sandbag.** Ideal for more robust uses that may require an extended temporary purpose, for example, continued flood prevention and defensive walls.

|   |   |
|---|---|
| Code  | CM999A  |
|  | Capacity: 28.5kg damp sand<br>25.5kg dry sand |
|  | 33x76cm (13x30")                              |



# BLAST BOXERS

The Original P.U.G - these protective under garments (P.U.G) offer protection against blast & fragments from IED's, and help guard against life changing injuries to the perineum and femoral arteries

## PERFORMANCE

Tested in accordance with MILSTD-662F | V50 2gr RCC



## P.U.G PROTECTIVE UNDER GARMENT



www.bcbin.com +44 (0)29 20 433 700

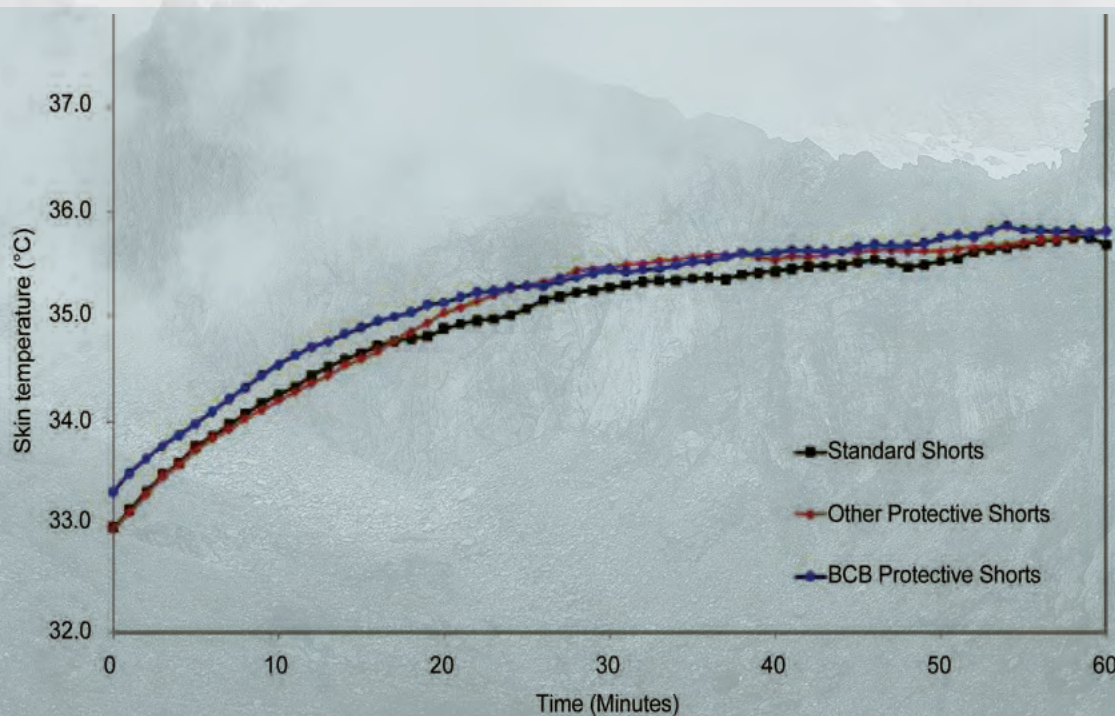

### Men's Sizes

| Waist |       |
|-------|-------|
| XS    | 24-26 |
| S     | 28-30 |
| M     | 32-34 |
| L     | 36-38 |
| XL    | 40-42 |
| XXL   | 44-46 |

### Women's Sizes

| Waist |       |
|-------|-------|
| XS    | 22-24 |
| S     | 25-27 |
| M     | 28-30 |
| L     | 31-33 |
| XL    | 34-36 |
| XXL   | 37-40 |





# BLAST BOXER™ MKI



Compression design **conforms to the body** with stretchy side panels.

Flat locked seams for **low bulk and low friction**.

High wicking fabrics allow **sweat to evaporate quickly** with **minimal drying time**.

High fabric permeability - **Breathable**, just like wearing regular underwear.

Can also be supplied with or without the ballistic inserts.

**DuPont™ Kevlar®** performance maintained after 25 washes at 105oF.\*

Ballistic insert protection V50 17gr FSP = 1391.5 ft/s.

**Anti-microbial fabric next to skin**. Tested to AATCC 100 with **99% bacteria reduction** after laundering in accordance to AATCC 135.



Sculpted design Box brief styling with sculpted genital area, 4" fly opening and overlap of ballistic material at the fly opening.

The ballistic inserts are **soft and highly flexible**. They do **not interfere with comfort during walking or running**.

Garment fully lined with the soft comfortable fabric to **minimise chaffing**.

**Greater protection - less weight**

Insert cover is welded to make them **waterproof**.

**Berry Amendment and made in America Act compliant**.

**Laboratory and field tested**.

Internal heat transfer care label.

**Patented - 8533863**

|   |                          |
|---|--------------------------|
| Code  | CB289                    |
|  | Medium - 141 grams (5oz) |

## PROTECTS THE FEMORAL ARTERIES

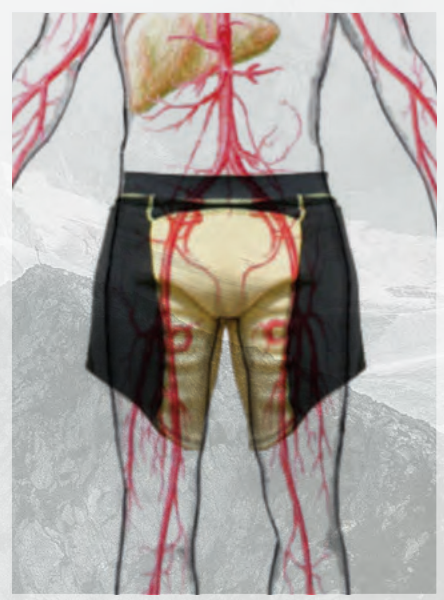

### FULLY BLAST TESTED:



Fragmentation penetrated only 1 layer

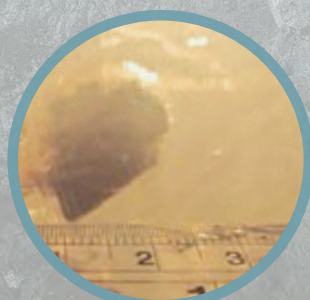

Ballistic gel with large fragment



Result from 15kilo charge - Material still intact



Zero trauma to femoral artery area

COOKING

HYGIENE

SURVIVAL

CAMO

CAMP

CLOTHING

MEDICAL

TOOLS

SPECIAL



# BLAST BOXERS

## BLAST BOXER™ MK II WITH REMOVABLE BALLISTIC INSERTS

- Patented
- Light weight mesh to keep wearer cool
- Boxer/brief styling with fly opening with 7.5cm (3") overlap
- Flame retardant materials throughout
- Helps protect blast and fragmentation injuries to the groin
- Lightweight
- Removable ballistic inserts to increase protection - Add the inserts when the threat level is increased
- No ballistic degradation following washing
- Can be worn with POGs for added protection
- Quick drying
- High air permeability and moisture evaporation or transfer
- Anti-microbacterial with over 95% bacteria reduction after 25 washes
- Fully Berry compliant if required



|  |                               |
|--|-------------------------------|
| Code   | CB489                         |
|  | Medium - 167 grams<br>(5.9oz) |

## BLAST BOXER™ MK III



- Sculpted design - improved look and increased comfort
- Greater protection - less weight - (less than 150 grams (5.3oz) for size medium)
- Breathable fabric - same thermal burden as regular underwear
- Laboratory and field tested
- Fully Fire Retardant
- Anti microbial and anti odour
- No ballistic degradation following washing
- Fully Berry compliant if required

Improved  
Look +  
Comfort

|   |                               |
|---|-------------------------------|
| Code  | CB589                         |
|  | Medium - 167 grams<br>(5.9oz) |



# P.O.G - PROTECTIVE OVER GARMENT



The original protective over garment just got better

The BCB POG strap provides as much **comfort** as possible whilst providing **high level ballistic protection to the groin and posterior.**

The front portion is designed with a clip to enable the wearer to easily urinate, without having to doff or unravel the garment.

**This feature seems like a small benefit, but it is amplified during an operation.**

- **Comfortable**
- Fully **adjustable**
- **NIJ Level IIIA** Jock –Strap design
- Front can be worn separate to the rear section
- **Easy to don and doff**
- Cupped shape to the front provides **space and airflow**
- Overall weight of just **970 grams.** Front portion weighing just 480 grams
- Rear attaches with one clip at the front and two G-Hook at the sides
- Each size is **adjustable to fit various shapes and sizes**
- Rear attachment **elasticated** to conform to the wearer's movements in use
- Rear can be **folded and stowed** on the back of the wearer
- **Robust and abrasion resistant** 500 denier Nylon carrier and Nylon webbing
- Designed to be worn over combat trousers
- Groin section is **soft and flexible** for comfort



|   |                    |
|---|--------------------|
| Code  | CB487              |
|  | 970 grams (34.2oz) |



# FLOATING BODY ARMOUR

## F.A.T.S

### FLOATING ARMOUR TORSO SYSTEM

COMFORTABLE, BUOYANT AND STRONG



**This innovative system provides comfortable armour with an integrated life jacket.**

The removable inflatable stole is located underneath the high performing level IIIA armour pack. **This protects the wearer and the life jacket from bullet or fragment threats.**

Having the lifejacket under the body armour also gives it a **low profile close fit.**

Other body armours with a neck external lifejacket catch on the helmet.

The gas inflatable stole is kitted out with an automatic trigger which deploys within seconds in water.

The armour vest expands around with the bladder when activated to provide continuous protection.

**Extensively independently tested.**

Available with a 175 Newton and a 275 Newton floatation capability.

**Automatically inflates within approximately 3 seconds of water immersion**



Life jacket can be removed if not required and the **body armour can be worn independently**

Up to 275 newtons of cylinder buoyancy can be topped up by manual inflator tube

**Unique 4 point expansion system allows the life jacket to inflate without crushing your chest**



Export licence needed for all Body Armour

+44 (0)29 20 433 700

www.bcbin.com

69



Tabard style tactical armour vest

Fully functional all-round **MOLLE system** to suit the task in any terrain

**Removable inflatable lifejacket** (Stole), with a choice of 175N or 275N capability

Vest expands with the inflation of the stole

**Self rights** to clear airways from the water

**Fully adjustable at the sides**

Internal elasticated waistband distributes the load of the vest

Rear grab handle

Mesh lining for better airflow and rapid drainage

Easy access bladder for re-arming, servicing and cleaning

**Lightweight** PU coated Nylon 500 denier outer fabric

Removable and adjustable crotch strap

Water resistant aramid used

Ballistic inserts made of low density and buoyant Ultra High Molecular Weight Polyethylene (UHMWPE)

Inserts protected with welded lightweight waterproof covers

Choice of protection tested in accordance to NIJ 0101.04 or NIJ 0101.06

Front and back 25 X 30cm (10"x12") **hard armour plate pockets**

**Protection level NIJ IIIA**



Two options available:

### Marines, navy and coastguard

270 Newtons for use during land assaults, ship boarding and general boat use. Large capacity for when wearing/carrying a rucksack heavy belt kit and weapons

| 275 Newtons - Navy Vest | Black                           | ATP Camo |
|-------------------------|---------------------------------|----------|
| Small                   | CL10SB                          | CL10SMC  |
| Medium                  | CL10MB                          | CL10MMC  |
| Large                   | CL10LB<br>NSN: 8470-99-156-1400 | CL10LMC  |
| X-Large                 | CL10XLB                         | CL10XLMC |

### Aircrew or vehicle crew

175 Newton bouyancy for aircrew and vehicle crew. Lower profile for use in confined space.

| 175 Newtons - Crew Vest | Black   | ATP Camo |
|-------------------------|---------|----------|
| Small                   | CL09SB  | CL09SMC  |
| Medium                  | CL09MB  | CL09MMC  |
| Large                   | CL09LB  | CL09LMC  |
| X-Large                 | CL09XLB | CL09XLMC |

**Both have the option of MOLLE or lazer cut finishes:**

**MOLLE:** more traditional

**Lazer cut:** less snag

Patents pending

**Watch the video here:**



**Black:**

**Multicam:**



# BODY ARMOUR

## THE KASTELL PRO®

POLICE/SWAT QUICK RELEASE PLATE CARRIER



This modular armour plate carrier vest is equipped with an **integrated quick release system** which works in less than **five seconds** and can be **re-assembled in less than 20 seconds**.

Designed to receive additional **protectors to the neck, shoulders, groin and coccyx** depending on the threat you are faced with.

The neck collar is adjustable

Fully adjustable shoulder brassards

Lined with a layer of fleece fabric.

Soft armour inserts inside  
(NIJ0101.06)

MOLLE groin and coccyx protectors



With transport bag

### Features:

- Weight without plates and soft armour inserts: 3kg
- D rings for attaching rifle slings.
- One size fits all. Height and width adjustment points on the shoulder and waist areas to fit all body sizes.
- MOLLE webbing on all faces of the plate carrier.
- Removable velcro ID badges.
- Designed for maximize comfort and to facilitate air circulation.
- Extra thick shoulders padding for greater comfort during prolonged patrols/missions.
- Fitted with a quad quick release system ideal when emergency medical treatment and tactical extraction are required.
- The quick release handle's are easy for right handed or left handed use.
- Can be worn while driving a vehicle.
- Does not restrict the firing position.
- Radio cables and hydration tubes can be threaded through.
- A strong evacuation handle.
- Back armour plate pocket can be moved up or down.



|   |       |
|---|-------|
| Code  | CL425 |
|  | 3kg   |



# THE KASTELL PRO AQUA®



Waterproof interior liner on front and back.

550 Decitex (500 denier)



Extra padding to maximize comfort

Comfort spacer pads on the inside to maximize air flow and moisture management



- Made from FR and **quick drying fabric**
- Weight = 3.28kg (inc belt, groin and coccyx protectors)
- Designed to receive NATO standard 'stand alone'.
- Level IV armour plates.
- **One size fits most.**
- **Easy to adjust.**
- Equipped with quad **quick release system** which can be activated in **5 seconds** and clipped **back together in 20 seconds**. Release system is in service with US Army.
- Two grab handles on the back for a **quick emergency extraction**.
- Cable management on right and left sides (including shoulders).
- Laser cut **MOLLE** finish.
- Can be supplied with removable level IIIA soft armour

## Quick release system:



## Vented pads:



## SEMI RIDGE PANEL



A high performance, lightweight and ultra-thin panel designed to provide discrete protection against hand guns, knives and explosions. Rated to NIJ Level IIIA 0108.01 (Ballistic resistant protective materials) which includes 44 magnum, 9mm and all lesser threats. Constructed from advanced proprietary technology and is available curved or flat. Dimensions 25 x 30cm (10 x 12") weighs 0.96lb (440 grams). Less 5mm thick (3/16 inch).

Can be used in a variety of different applications including backpacks, clipboards, briefcases, handbags, trauma armour, structural armour, upgrade plates etc.

|   |  |
|---|--|
| Code  | CL425  |
|  | With extras*: 3.28kg (7.2lbs)<br>Without extras: 2.16kg (4.7lbs) |

\* Extras = Belt, groin and coccyx protectors

## ICW



Multi curve design for improved comfort and ergonomics. Must be used with NIJ IIIA soft armour.

Available in five different configurations;

- 1/ NIJ IV ICW
  - a/ 2.45KG plate.
  - b/ 2.1KG plate.
- 2/ NIJ III ICW
  - a/ 1.95KG plate.
  - b/ 1.7KG plate.
  - c/ 1.25KG plate (inherently buoyant)

COOKING

HYGIENE

SURVIVAL

CAMO

CAMP

CLOTHING

MEDICAL

TOOLS

SPECIAL





# BODY ARMOUR

## MICH WITH RAILS



A reduced weight, higher cut at the back and sides and removal of the front peak. This new low profile provides excellent compatibility with communications equipment, gas masks and especially helmet mounted night vision goggles. The helmet is constructed from para aramid material and provides lightweight, robust protection from ballistic and fragmentation projectiles and other low energy threats. Protection against fragments from V50 450m/sec V50650m/sec according to STANAG 2920 (17gr FSP) and US MIL STD 662F. Ballistic protection is NIJ IIIA.

|   |              |
|---|--------------|
| Code  | CL532        |
|  | 1.4kg (3lbs) |
|  | NIJ IIIA     |

Produced using high tenacity Kevlar aramid material Crown Mesh Internal Suspension System for improved airflow and stand off from head with 4 point adjustable harness system. Large neck support nape pad for improved comfort and helmet stability. Accessory side rails for attachment of equipment. Front facing shroud for attachment of night vision goggles. Fragmentation Protection V50 640 m/s against 1.1g FSP in accordance with STANAG2920 Shock absorption to EN397 Standard

## TACTICAL SPECIAL FORCES





|   |          |
|---|----------|
| Code  | CL062    |
|  | NIJ IIIA |

## COVERT





This concealed undervest is a side opening vest with adjustable shoulder closures. It has pockets for Trauma and Hard armour plates and can withstand multiple hits. It is easy to maintain having removable and machine washable covers. Standard colours are: white, black, navy blue and beige. Other colours are available on request.

|   |                |
|---|----------------|
| Code  | CL216          |
|  | 2.5kg (5.5lbs) |
|  | NIJ IIIA       |

- Unmatched protection
- No sacrificing comfort
- Keeps you in total control of any situation.

Already protecting many people around the world, it can be customised to meet your needs with additional armour coverage, MOLLE pouches, Velcro patches etc.

|   |              |
|---|--------------|
| Code  | CL533        |
|  | 3kg (6.6lbs) |
|  | NIJ IIIA     |

## OVERT





## The most complete protection available.

Combining our commitment to **comfort and versatility** with **extreme protection**, this vest is available in the highest NIJ Levels to guarantee you unsurpassed safety.

Complete with front, back and side panels, neck, throat, groin and upper arm protection.

This armour remains **flexible and as light as possible**.

Also includes MOLLE™ webbing for extreme flexibility and comfort.

## MAX PROTECT



|      |          |
|------|----------|
| Code | CL198    |
|      | NIJ IIIA |

## BALLISTIC BLANKET

Designed to provide a portable, flexible, lightweight, compact and multi-purpose means of ballistic protection. It has a number of loops around its perimeter, enabling it to be hung from objects, such as fences, when protection is required.

Magnets mean that it can also be rested against cars, vans and other metal objects. It can be folded for storage and has handles for ease of transportation and deployment. Other sizes are available on request.

|      |                            |
|------|----------------------------|
| Code | CL534                      |
|      | 125 x 125cm (49.2 x 49.2") |
|      | NIJ IIIA                   |



A breathable, comfortable, thin layer of clothing that will protect you from the threat of a blade edge and sharp cuts. This vest offers protection whilst remaining concealed. The material is lightweight, comfortable and breathable without compromising cut and slash protection.

Concealable- wear alone or under a shirt.

Comfortable, breathable and lightweight knit

Soft, cotton-reinforced neck, arm and wrists.

Choose sleeveless or long sleeve.

Suitable For:

- Security Personnel
- Club Security
- Law Enforcement and Prison

## STAB SHIRT



|      |                    |
|------|--------------------|
| Code | CL064 (Sleeve)     |
|      | CL063 (Sleeveless) |
|      | NIJ IIIA           |

## ARMOUR PROTECTION LEVELS

| NIJ IIIA  | ICW NIJ III                              | ICW NIJ IV                                | NIJ IV   |
|---|--|---|--|
| Hand Guns<br>9mm, .44                           | Rifles<br>5.56, 7.62 (NATO)              |   | Armour Piercing<br>7.62 AP                                     |
| Semi Rigid Panel (<1kg)<br>Or Soft Armour (3kg) | ICW Plate and<br>Soft Armour<br>(>5.5kg) | ICW Plate with<br>Soft Armour<br>(>7.2kg) | ICW Plate with Soft Armour<br>or Stand Alone Plate<br>(>6.1kg) |

## VEST CUSTOMISATION

At BCB we want the solution to best fit the requirement and balance this with your available budget. To achieve this, we offer the option to customise and build a bespoke product just for you.

This can involve simple changes in features and functions e.g. one of both side openings, to different colours and patterns, or adding improvements such as a quick release system.

Call or email us to discuss your requirements, should the above standard options not be exactly what you are after.



# GLOVES

ALL GLOVES ARE AVAILABLE IN MULTIPLE STANDARD SIZES

- **Supple high quality water, heat and oil resistant goatskin outer**

- Comfortable 3 dimensional aramid composite lining

- Suede leather palm reinforcement

- **High impact-resistant foam padding** to back of hand, fingers and wrist to protect against trauma hazards

- Sewn with fire-resistant thread

- **Fully waterproof, breathable microporous membrane** providing additional limited protection against:

- Petrol, certain acids and other chemical risks

- Blood-borne pathogens (ASTM 1671)

- Available in sizes: 6-13

|      |       |
|------|-------|
| Code | CB295 |
|------|-------|

## PUBLIC ORDER GLOVES



## COMBAT GLOVE



- This Lightweight Glove is designed with comfort and functionality in mind

- The glove offers **premium flexibility, feel and protection**

- Reinforced **carbon fibre** knuckle and hand protection design

- High grade aniline goatskin leather

- The mid-height soft cuff does not restrict movement

- Velcro fastening strip

- Breathable sides to fingers

- Available in **Tan** and **Black**

|      |         |
|------|---------|
| Code | CB215 ● |
|      | CB214 ● |

- An extremely lightweight (15 gram, 0.5oz) tactical glove that offers cut and burn resistance without compromising tactile abilities.

- Heat resistant - ideal for stripping a hot GPMG or working with vehicles in a hot environment

- Cut-resistance

- Puncture-resistance

- Tight fitting

- Silicone printing gives excellent non-slip grip

- Can operate touch screens

|      |       |
|------|-------|
| Code | CB216 |
|------|-------|

- Excellent tactility

## HOT WEATHER GLOVES





## COBRA GLOVE



- Cobra features an unlined trigger finger for optimum weapons handling
- Ideally suited to training and operations where simultaneous operation of firearms is required
- This glove offers **high levels of protection** combined with **durability and dexterity**
- Specially formulated **waterproof and abrasion-resistant coated Kevlar® fabric outer**
  - Double layer on palm
  - **Fire-resistant Nomex® III lining**
  - **Unlined leather trigger finger**
- EN388: 1994 4.3.4.4 Certified
- Available in sizes: 7-12

|             |                         |
|-------------|-------------------------|
| <b>Code</b> | RGKI31                  |
|             | RGKI31A (Roping option) |

- A performance mitten offering excellent warmth and a supple synthetic palm for added dexterity and feel
- 100% Waterproof, Windproof & Breathable
- Soft and durable synthetic palm for grip and easy washing
- PU suede wiper on thumb for a multitude of uses
- Size Options - S, M, L, XL, XXL

|             |      |
|-------------|------|
| <b>Code</b> | MC13 |
|-------------|------|

## MITTENS



- Camouflage print lightweight tactical gloves
- Integrated breathability to keep hands dry and comfortable
- Elasticated cuffs for secure fit
- Fingertip design reduces wear over time

|             |       |
|-------------|-------|
| <b>Code</b> | CB259 |
|-------------|-------|

## LIGHTWEIGHT TACTICAL GLOVES



COOKING

HYGIENE

SURVIVAL

CAMO

CAMP

CLOTHING

MEDICAL

TOOLS

SPECIAL



# BASE LAYERS

**MADE FROM MERINO WOOL, BCB'S BASE CLOTHING IS OF THE HIGHEST QUALITY AVAILABLE**

## BASE LAYER TOP



Our base layers are made from 100% natural Merino wool, helping your garment stay fresh and odour-free, actively wicking away moisture from the skin – keeping you dry and comfortable.

These garments also provide extra comfort and warmth, due to the soft and tightly-knit material

|   |                                 |
|---|---------------------------------|
| Code  | MC02 (Top)<br>MC01 (Long Johns) |
|  | S, M, L, XL, XXL                |

## THERMAL SOCKS



Thermal Liner Socks have a high wool content for comfort and warmth.

They can be worn as a liner or as an everyday sock.

|   |                  |
|---|------------------|
| Code  | MC04D            |
|  | 25 grams (0.9oz) |

## BASE LAYER LONG JOHNS



**100%  
NATURAL  
MERINO  
WOOL**





## LINER GLOVE



**Extra  
Comfort**

Close fitting inner gloves in fine Merino wool for increased comfort

Ideally worn under our range of waterproof gloves to give added insulation.

Extra comfort and moisture control – High Merino Wool content.

Added warmth and protection from full finger design

Breathability – Fabric wicks sweat away

One Size

|   |                   |
|---|-------------------|
| Code  | MC08              |
|  | 150 grams (5.3oz) |

## Scarf



## Balaclava



## Hat



## Headband



## HEADOVER



**Multiple  
ways to  
wear**

|   |                      |
|---|----------------------|
| Code  | MC135                |
|  | 150 grams<br>(5.3oz) |

- Elastic - maintains its original shape
- Made from 130g/m Merino wool
- Available in black
- One size fits all

The Headover is a **very versatile garment**. It can be used as a **scarf, headband, balaclava or hat**.

COOKING

HYGIENE

SURVIVAL

CAMO

CAMP

CLOTHING

MEDICAL

TOOLS

SPECIAL



# HEADWEAR

With cooling chamber and removable neck guard

A classic military style hat designed for operations in hot climates

Mesh netting (backed with fine mosquito netting) helps ventilate the head

An integral poly-crystal chamber in the top of the hat can also be immersed in water to provide extra cooling to the cranium. Simple but very effective

## HOT WEATHER HAT







## BOONIE HAT



Simply immerse in water for 10-20 minutes

Can be used with or without water Mesh ventilation

Available in desert and woodland camo



| Product   | Hot Weather | Boonie   |
|---|-------------|--|
| Code  | CL087       | CB035A <br>CB035B  |
|  | 90* grams   | 100* grams   |
|  | S, M, L, XL | L, XL, XXL   |

\*measurement is approximate

A simple, but highly efficient body cooling product that works by evaporation

To activate soak in water for 20 minutes and it will stay cool all day!

Cools the jugular in your neck - a key area to keep cool

|   |                      |
|---|----------------------|
| Code  | CL085S               |
|  | 20g (0.7)            |
|  | 90x4.5cm (35.4x1.7") |

## NECK COOLING SCARF





## SHEMAGH



Classic desert head wear provides protection from sun, sand and wind

Also useful as winter headgear doubles as a useful sweat mop, dust wiper and field towel as required

|      |   |
|------|---|
| Code | CB224S ●<br>CB224 ●<br>CB224RB ●<br>CB224BB ● |
|      | 180 grams (6.3oz)                             |
|      | 110x110cm (43x43")<br>117x117cm (46x46")      |

Larger version in sand only, covers helmet and face



## MOSQUITO HEAD NET



A fine weave anti-mosquito head net

Protects from mosquitoes, gnats, midges, horse flies, ticks, tsetse fly and most other biting insects

Features adjustable head cord. Can be worn over most military head dress and under helmets

Small enough mesh to stop sand flies

Very comfortable to wear

Colour: Olive green



|      |                      |
|------|----------------------|
| Code | CL2252A              |
| NATO | NSN-8405-99-130-2605 |
|      | One size fits all    |



# STAY PROTECTED.

COOKING

HYGIENE

SURVIVAL

CAMO

CAMP

CLOTHING

MEDICAL

TOOLS

SPECIAL



# FOOTWEAR

## PANTHER 8.0

- Padded collar for comfort
- Fast wicking lining for moisture management & comfort
- Durable leather upper with hardwearing breathable mesh
- Durable rustproof hardware
- EVA insole for shock absorption & comfort
- High traction rubber outsole designed for maximum grip



| Code | (No zip)        | (Zip)            |
|------|-----------------|------------------|
|      | CC048           | CC048A           |
|      | 710g*<br>(25oz) | 590g<br>(20.8oz) |



## STRIKE FORCE 8.0



High traction rubber outsole designed for maximum grip

Padded collar for comfort

Fast wicking lining for moisture management & comfort

Armourgel ultimate ankle impact protection

Durable leather upper with hardwearing breathable mesh panels

Scanner safe non-metallic composite hardware

Compression molded RECOIL midsole absorbs impact and provides all-day support and comfort

M-P.A.C.T Response insole for maximum comfort & shock absorption



Code CC071



620g\*  
(21.8oz)



## VIPER PRO 5.0

Padded collar and tongue for comfort

Ankle pads for added protection

Durable leather upper with hardwearing breathable mesh panels

EVA midsole for underfoot comfort

Scanner safe, non-metallic composite

Fast wicking lining for moisture

Waterproof & breathable boot membrane keeps feet dry

M-P.A.C.T Response insole for maximum comfort & shock absorption

High traction rubber outsole designed for maximum grip



|   |                   |
|---|-------------------|
| Code  | CC247             |
|  | 530g*<br>(18.6oz) |

\*Based on 1/2 pair US 9/EU 42/UK 8

## HERA MONSTER

Breathable suede leather

Primer: \* Gore-tex membrane

Highly breathable

Durable and 100% waterproof

Double density polyurethane / rubber sole technology

Antistatic and oil resistant

Shock absorption and softness provides comfort

Provides superior mobility and stability

Anatomically shaped, washable, shock absorbing outer



|      |       |
|------|-------|
| Code | CC072 |
|------|-------|

COOKING

HYGIENE

SURVIVAL

CAMO

CAMP

CLOTHING

MEDICAL

TOOLS

SPECIAL



# FOOTWEAR

## MONSTER DESERT BOOT



Zipper

Breathable suede leather, woven polyamide 6.6 (Cordura®) textile panels with interlocking knitting system

Inner Lining: 65% Polyester

Dry-Touch® absorbs perspiration and dries quickly

Sole Technology: Double density polyurethane / rubber

Shock absorption and softness provides the most comfort

Engineered base design provides superior mobility and stability when climbing or overcoming obstacles

Reinforced thermoplastic dome

Code CC073

Highly breathable genuine nubuck leather

Zipper

Injection base technology; shock absorption and softness provide the user with optimal comfort

Water repellent Cordura textile panels knitted with locked knitting system

Rubber outsole resistant to abrasion and slip

Provides superior mobility and stability when climbing or crossing obstacles in terrain

Code CC074

## MNTP TACTICAL BOOT





## ROUND BOOT LACES



Strong & extra long  
Contains one pair  
Black

|  |             |
|--|-------------|
| Code   | CC009       |
|  | 160cm (64") |

Strong, long, high quality all-purpose shoe laces

|  |               |
|--|---------------|
| Code   | HG050         |
|  | 60cm (18.75") |



## BLACK SHOE LACES



Eliminates the chore of repeatedly lacing boots

9 holes

Strong brass zip

|   |                       |
|---|-----------------------|
| Code  | CC2241                |
|  | 50 grams (1.8oz)      |
|  | 12x5x1cm (4.7x2x0.4") |

## 9 HOLE BOOT ZIPS



Secure your combats for an inspection quality look in an instant  
Green elasticsated double twist cord  
Useful for cycling  
Two pairs per pack



|      |                      |
|------|----------------------|
| Code | CC2238               |
| NATO | NSN-8415-99-498-8961 |

## TROUSER TWISTS X4



COOKING

HYGIENE

SURVIVAL

CAMO

CAMP

CLOTHING

MEDICAL

TOOLS

SPECIAL



# DRY BAGS



Fully submersible dry bags manufactured from hard wearing black coated nylon

Features a roll-down closure with quick release

Excellent as a rucksack liner

The 60 litre has a clear viewing strip and valve

The valve allows you to either inflate the bag if needed or to expell air to reduce the overall volume

|   |                      |                        |
|---|----------------------|------------------------|
| Code  | CA960                | CL081                  |
|  | 90 litre             | 60 litre               |
|  | 79 x 89cm (31 x 35") | 79 x 63.5cm (31 x 25") |

## RUCKSACK DRY BAG - WITH COMPRESSION VALVE



## GIANT WATERPROOF KIT BAG

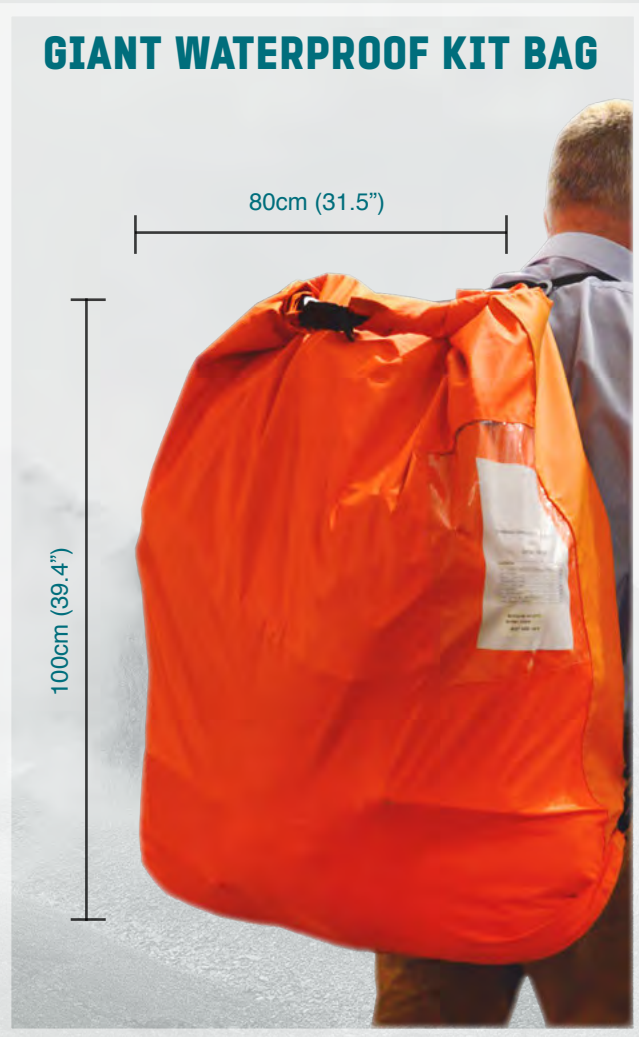

Several locations for attaching the strap, allowing flexibility

Can be carried as a rucksack or dragged along the ice/snow

**Folds down flat**

Material: PVC/nylon

**Bright orange colour**

Taped seams



Rollover top



|   |                       |
|---|-----------------------|
| Code  | CA980                 |
|  | 90 litres             |
|  | 80x100cm (31.5x39.4") |



- Tough flexible waterproof PVC
- Roll top design
- RF welded seams
- Highly visible orange
- Watertight
- Comfortable shoulder straps
- Comfort back support
- Carry handle
- Easily compressed

|   |                                |
|---|--------------------------------|
| Code  | CA955                          |
|  | 820 grams (28.9oz)             |
|  | 53x40x23cm<br>(20.8x15.7x9.1") |

## 40 LITRE WATERPROOF RUCKSACK



## HEAVY DUTY CORDURA EXPEDITION BAG



This bag is made of a Cordura material. It has four strap handles on the top to make a four/two man carrying system for easy mobility.

A drag strap has been added if the user wishes to drag the bag across any environment.

Reinforced plastic feet ensure the bag is protected from the terrain.

- Easy to carry
- Detachable straps if the user needs to drag across ice
- High visibility
- Cordura Materials to be used on the ice
- Four/Two handled pulling system

RIGHT HAND SIDE

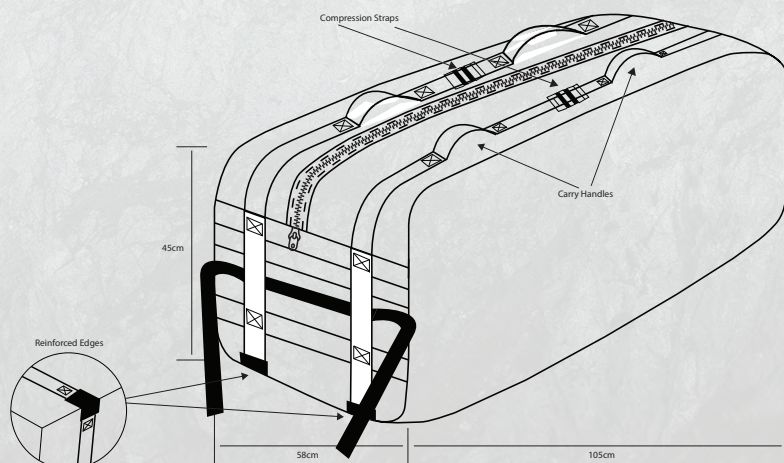

|  |                                      |
|--|--------------------------------------|
| Code   | CA970                                |
|  | Volume: 274 Litres<br>(482.26 Pints) |
|  | 105 x 58 x 45 cm<br>(42 x 23 x 18")  |

COOKING

HYGIENE

SURVIVAL

CAMO

CAMP

CLOTHING

MEDICAL

TOOLS

SPECIAL



# FIRST AID KITS

A **useful multicam pouch** with zip closure that **reveals a number of pouches** when opened. Contains a **variety of first aid products** suitable for the treatment of minor injuries



- Tweezers • Antiseptic Wipes • Waterproof Plasters • Wound Close Strip • Resuscitator With One Way Valve
- Various Dressings • Paratulle • Triangular Bandage
- Crepe Bandage • Anchor Dressing • Conforming Bandage • Disposable Gloves • Safety Pins • Scissors
- Plaster Strip • Microporous Adhesive Tape • Zinc Oxide Tape • Razor Blades • Pouch

|      |   |
|------|---|
| Code | <b>CS113M</b> ●   |
|      | 430g (15oz)   |
|      | Closed: 18x12x9cm (7x4.7X3.5")<br>Open: 38x12x4.5Cm (15x4.7X1.7") |



## MILITARY F.A.K

46  
Items



A **handy pocket sized pouch** with belt tunnel loop, containing **basic medical kit**. Excellent for hikers who want to **travel fast and light**.



## PERSONAL FIRST AID KIT

- Antiseptic Wipes
- 10 X Adhesive Dressings
- Medium Wound Dressing
- Triangular Bandage
- Set Of Safety Pins
- Accident Evaluation Report
- Instruction Leaflet
- Pouch

|      |                                   |
|------|-----------------------------------|
| Code | <b>CS476</b> ●<br><b>CS476M</b> ● |
|      | 65 grams                          |
|      | 10x17.5x4.5cm<br>(3.9x6.9x1.8")   |

22  
Items







## LIFESAVER 1

30  
Items



- Bandages
- Dressings
- Plasters
- Antiseptic Wipes
- Scissors
- Safety Pins
- Instructions

|      |                             |
|------|-----------------------------|
| Code | <b>CS111</b>                |
|      | 138 grams<br>(4.9oz)        |
|      | 14x13x4cm<br>(5.6x5.1x1.6") |

The Lifesaver #1 is a large pocket size kit for day trips

- antiseptic wipes x 2
- adhesive dressings x 10
- suture plaster
- medium wound dressing
- paraffin gauze burn dressing
- triangular bandage
- knuckle "h" shaped bandage
- white open weave bandage
- medical gloves (pair)
- set of

safety pins • scissors • accident evaluation report • crepe bandage • instruction leaflet • lifesaver pouch



## LIFESAVER 2

35  
Items



|      |                           |
|------|---------------------------|
| Code | <b>CS110</b>              |
|      | 320 grams<br>(11.3oz)     |
|      | 23x19x5cm<br>(9.1x7.5x2") |

The Lifesaver #2 intermediate kit is for longer journeys and larger groups of people.

- antiseptic wipes x5
- adhesive dressings x10
- suture plaster
- medium wound dressing
- paraffin gauze burn dressing
- weave bandage
- medical gloves (pair)
- set of

safety pins • scissors • microporous adhesive tape • accident evaluation report • hospiform bandage • instruction leaflet • isotonic drink • lifesaver pouch • anchor dressings • conforming bandage



# FIRST AID KITS



## LIFESAVER 3



41  
Items

The Lifesaver #3 advanced kit, which can be used as the basis for an expedition medical kit.

- Resuscitation device • Isotonic drink • 5 antiseptic wipes • Large crepe bandage • Small crepe bandage • Wound dressing No.8 • Eye dressing No.16 • Conforming bandage • Hospiform bandage • Anchor dressing • Large ambulance dressing • 10 assorted adhesive dressings • 2 paraffin gauze dressing • Triangular bandage • 6 safety pins • Pair of scissors • Pair of tweezers • Strip fabric dressing • Pair of disposable gloves • Microporous adhesive tape • 5 Sutures • Accident evaluation report • Instruction leaflet • lifesaver pouch

|   |                        |
|---|------------------------|
| Code  | <b>CS115</b>           |
|  | 500 grams (17.6oz)     |
|  | 23x19x5cm (9.1x7.5x2") |

## LIFESAVER 4





LIFESAVER  
First Aid  
comprehensive  
instructions  
inside

41  
Items

- Tough, Durable Pouch
- Water Resistant Zip
- Multiple Clear Compartments
- Belt Loops
- Easy to Access

- Calico Triangular Bandage 90Cm X 127Cm • No 8 Medium Dressing Sterile • No 2 Ambulance Dressing Sterile • Cotton Gauze Swabs 8Ply 7.5Cm X 7.5Cm (X5) • Extra Large Dressing No 3 • Elastic Adhesive Bandage 7.5Cm X 4.5M • Paraffin Gauze 10Cm X 10Cm (X10) • First Aid Scissors • Pe Gloves (X5) • Safety Pins (X6) • Burn Bag Double Sided Adhesive Sticker 29Cm X 42.5Cm • Assorted Washproof Plasters (X20) • Zinc Oxide Tape (White) 1.25Cm X 5M • Lifesaver Instruction Leaflet •

|   |                          |
|---|--------------------------|
| Code  | <b>CS119</b>             |
|  | 240 grams                |
|  | 14x15x7cm (5.5x5.9x2.7") |



## LIFESAVER 6

- Tough, Durable Pouch
- Water Resistant Zip
- Multiple Clear Compartments
- Belt Loops
- Easy to Access



44 Items



- Calico triangular bandage 90cm x 127cm
- No 8 medium dressing sterile
- No 2 Ambulance dressing sterile
- Cotton gauze swabs 8ply 7.5cm x 7.5cm (x5)
- Extra large dressing No 3
- Elastic adhesive bandage 7.5cm x 4.5m
- Paraffin gauze 10cm x 10cm (x10)
- First aid scissors
- PE gloves (x5)
- Safety pins (x6)
- Burn bag double sided adhesive sticker 29cm x 42.5cm
- Assorted washproof plasters (x20)
- Zinc oxide tape (white) 1.25cmx5m
- LIFESAVER instruction leaflet

|      |                           |
|------|---------------------------|
| Code | <b>CS124</b>              |
|      | 560 grams (19.8oz)        |
|      | 26x14x7cm (10.2x5.5x2.7") |

## TOURNIQUET



- Unique metal buckle design
- True one-hand application.
- The strap adapt any environment, mud , sand, snow, ice, etc.
- Strengthened clips, ensure you safe.
- Lightweight windlass rod, less than 16g, let it with you as far as you go.

|      |                           |
|------|---------------------------|
| Code | <b>SF112A</b>             |
|      | 60 grams (2.1oz)          |
|      | 26x14x7cm (10.2x5.5x2.7") |

## CHEST SEAL NON VENTED AND VENTED



The Chest Seal is a sterile occlusive chest wound dressing for treating open pneumothorax and preventing tension pneumothorax that result from gunshots, stabwounds, or other penetrating chest trauma

|      | Non Vented                 | Vented                     |
|------|----------------------------|----------------------------|
| Code | <b>RM259C</b>              | <b>RM259B</b>              |
|      | 30 grams (1oz)             | 30 grams (1oz)             |
|      | 17 x 20 cm<br>(6.7 x 7.9") | 17 x 20 cm<br>(6.7 x 7.9") |



# FIRST AID KITS

## TRAUMA PACK

### First Responder Emergency pack

The Pack has been trialled by emergency staff in Africa and is a **low-cost kit that can be used by anyone.**

The pack comes with simple, but **life-saving instructions which are colour and number coded for easy use.**

|   |                             |
|---|-----------------------------|
| Code  | CK062A                      |
|  | 1.3kg (45.9oz)              |
|  | 35x35x8cm<br>(5.5x5.9x2.7") |



**1**  
Bandages – several bandages and gauze for bleeds, gloves, and a tourniquet



**2**  
Airway – 2 sizes, with tongue depressors



**3**  
Neck – Tear and Wear neck collar, adjustable in size



**4**  
Burns – Cling film



**5**  
Pelvis – Pelvic sling with buckle



**6**  
Limbs – Foldable arm and leg splint with Velcro ties



**7**  
Transport – Lightweight stretcher with handles



**8**  
Warm – Lightweight hypothermia prevention



User-friendly PAD reliable for any rescuer even without minimal training.

Designed for public access use and licensed to administer fast and safe treatment against cardiac arrest, anytime and before the EMS team arrives. Practical, intuitive with CPR guidance and clear instructions supporting the rescuer through the protocol for an effective lifesaving action. Small and lightweight, works with long-life batteries for maximum portability.

Dimensions: 26.5 x 21.5 x 7.5cm (10.4 x 8.4 x 2.9")

Battery options: disposable or rechargeable

Power options: 200J or 360J

Code **DEFIB001A**

## SAVER ONE PUBLIC ACCESS DEFIBRILLATOR



## DEFIBRILLATION PADS



Disposable, pre-gelled and self-adhesive with a 30 month shelf life

Code **DEFACC02**

A versatile and lightweight first aid kit.

The ultralight dry bag keeps the weight down and helps keep your first aid kit safe and dry.

A durable buckle secures the roll-top closure and acts as a grab handle.

Accident Evaluation Report • Large Disposable Gloves • Folding Scissor • Waterproof Sterile Plasters • Anchor Dressing • Antiseptic Wipes • Safety Pins • Conforming Bandage • Paracetamol • Triangular Bandage (Non Woven) • Dressings • Wound Closure Strip • Hospiform Bandage • First Aid Hints • Ultralight Dry Bag (Red, 1 Litre)

## WATERPROOF F.A.K



Code **CK702**

## FIRST RESPONSE MEDICAL KIT



- The First Response Pull-Out Medical Kit contents can be pulled out quickly.
- All items openly displayed for easy access
- Great in low light
- With MOLLE webbing
- Saves valuable time when a life threatening injury needs immediate attention
- Pull-out in one swift movement
- The contents can then be folded out in front of the casualty ready for treatment
- Can be pulled out easily with left or right hand
- Velcro ID patch on front

Code **CS123**

COOKING

HYGIENE

SURVIVAL

CAMO

CAMP

CLOTHING

MEDICAL

TOOLS

SPECIAL



# MEDICAL

## A life-saving product for all dismounted soldiers

The personal stretcher is **easily and securely fastened by Molle** to the back of the soldier's body armour, from which it can be opened in a **matter of seconds**

The stretcher enables an injured soldier to be **quickly carried to safety** and receive medical attention

Made from lightweight and robust fabrics

Packs flat and fits between the body armour and the daysack

### Features:

Six long grab handles for **easy transportation**

Available in **all camouflage patterns**

Made from **robust rip stop nylon** and **high tensile strength nylon webbing**

**IRR treated**





Carry Bag Included



## CARRY SHEET



|   |  |
|---|--|
| Code  | <b>CT100</b>   |
|  | 280g (10oz)  |
|  | Closed: 28x24x1.8cm<br>(11x9.4x0.7")<br>Open: 190x75cm<br>(74.8x29.5") |

**Secure for the casualty - the stretcher is attached to their body armour**



## MICRO STRETCHER



The Micro-Stretcher is a lightweight, compact yet rigid stretcher

For rough terrain or where there may be limited access.

Quick to deploy

Compact

Can be utilised as part of a back-pack



|   |  |
|---|--|
| Code  | MF451  |
|  | <b>Packed:</b> 5.1kg<br><b>Unpacked:</b> 4.6kg   |
|  | <b>Closed:</b> 28 x 24 x 1.8cm<br>(11 x 9.4 x 0.7")<br><b>Open:</b> 190 x 75cm<br>(74.8 x 29.5") |

## CLIMBING/MARINE BASKET STRETCHER



Extra  
Secure

A rigid basket stretcher with multiple hand holes, lifting points & foot plate.

For hand, rope and helicopter rescue.

- Suitable for a wide range of situations.
- Strong polyethylene and aluminium structure
- Adjustable lifting bridles available
- Complete with patient restraint straps
- Moulded runners and handholds

|   |   |
|---|---|
| Code  | MF400A  |
|  | <b>Weight:</b> 13.5 kg (29.7lbs) <b>Capacity:</b> 278 kg (612.8lbs) |
|  | 217 x 62 x 18.5cm (85.4 x 24.4 x 7.2")                              |

COOKING

HYGIENE

SURVIVAL

CAMO

CAMP

CLOTHING

MEDICAL

TOOLS

SPECIAL



# MEDICAL

## FOLDING STRETCHER

The folding stretcher is a duo-fold design, allowing a normally bulky item to require minimum storage space when not in use

- The aluminium frame, is both **strong yet lightweight**
- Stretcher bed is **resistant to fluid and is extremely easy to clean**
- Once locked open, the **frame keeps the patient clear of the ground**
- **High strength aluminium alloy frame**
- **Waterproof, fireproof, anti-cracking material**
- Hi-Vis orange or olive
- **Easy to clean**

Minimal  
Storage  
Space

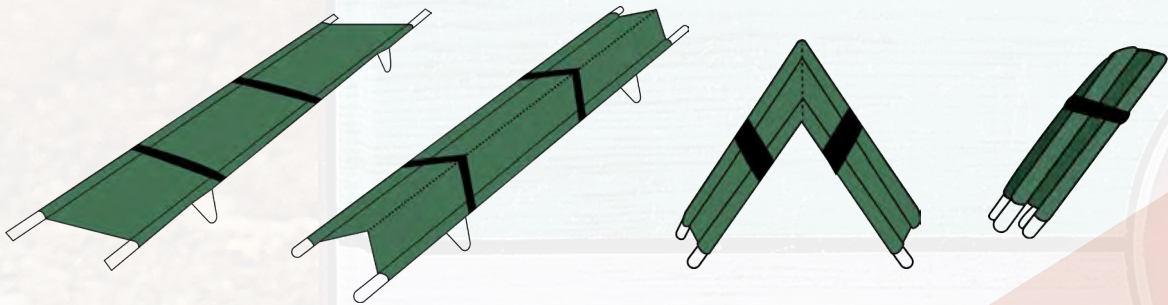

Folds both horizontally and vertically:



- Complete with **fully zipped carry bag and straps**
- Very strong: can carry **up to 159kg (350lbs)**

Frame  
keeps  
patient off  
ground



|   |   |
|---|---|
| Code  | <b>MF446</b>                                    |
|  | 5.4kg (12.1lbs)                                 |
|  | <b>Open:</b><br>14x52x206cm<br>(5.5x20.4x81.1") |
|   | <b>Folded:</b><br>10x18x103cm<br>(3.9x7x40.5")  |



## INFLATABLE STRETCHER



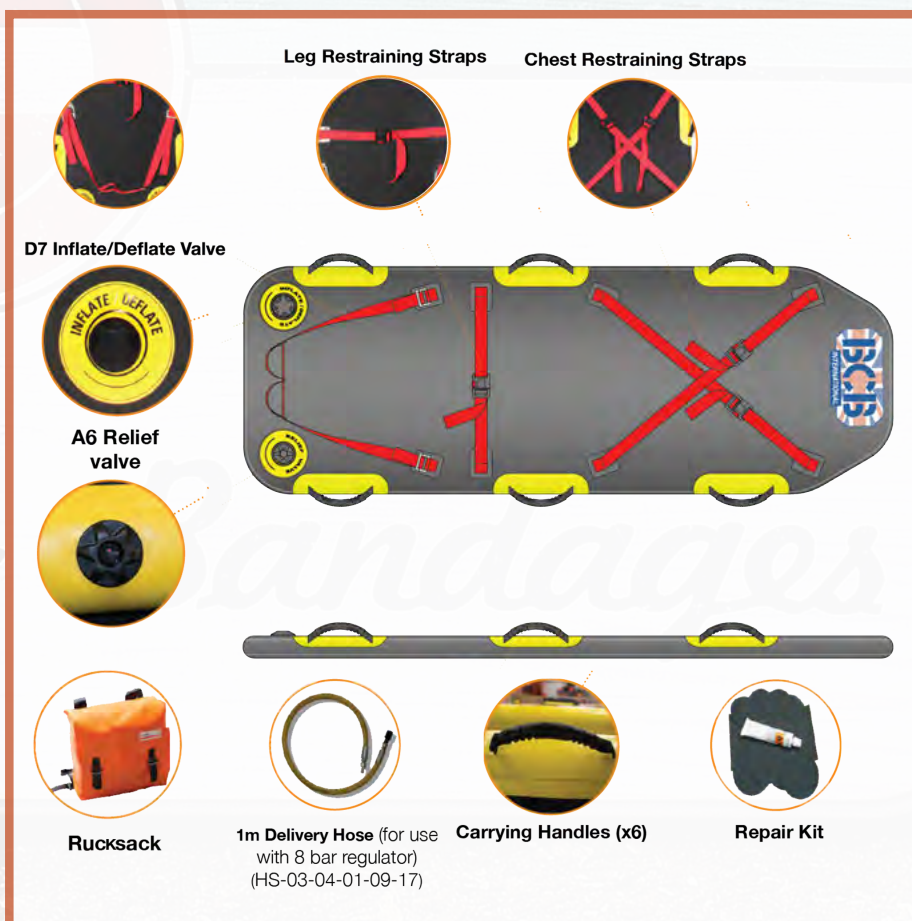

The super lightweight Inflatable Stretcher floats. Great for marine or mud environments.

The stretcher is able to be packed down into a small back pack to make it easier for transportation.



- Light weight and easily portable
- Compact
- Easy to Deploy
- Ideal for casualty recovery in tight or difficult to reach areas
- Individuals are secured with a quick release restraint harness
- The recovery board will comfortably accommodate adults up to 198cm (6'6") tall and 150kg (23.5st) in weight.
- Minimal training, servicing and maintenance costs

|   |  |
|---|--|
| Code  | <b>MF449</b>   |
|  | 6.5kg (14.3lbs)  |
|  | <b>Open:</b><br>203x69.5x6.7cm<br>(80x27.3x2.6")<br><b>Packed:</b><br>35x35x18cm<br>(13.8x13.8x7") |

COOKING

HYGIENE

SURVIVAL

CAMO

CAMP

CLOTHING

MEDICAL

TOOLS

SPECIAL





# MEDICAL

Lightweight malleable splint

Versatile and flexible

Use to immobilise and support broken or sprained limbs

Compact when rolled

|   |   |
|---|---|
| Code  | <b>RY273</b>                                |
|  | 140g (5oz)                                  |
|  | Rolled: 11x8cm (4.5x3")<br>Open: 91cm (36") |

## ANACONDA SPLINT



With one-way valve

A professional kit that helps save lives

This should be in every first aid kit for use during CPR or just kept in your car, home, office or handbag

Lightweight & portable

Ideal for anyone who may need to carry out first aid or CPR



Code **CS122**

## RESUSCITATOR



Large dressings sealed in a robust flexible waterproof pouch maintaining sterility and shelf life

Can be folded in several different ways to give excellent compression to stop bleeding wounds

|   |  |
|---|--|
| Code  | <b>PF118A (Small)</b><br><b>PF116A (Large)</b>       |
| NATO  | NSN-6510-99-210-7562 (S)<br>NSN-6510-99-210-7563 (L) |
|  | 60g (2.1oz) (S)<br>98g (3.5oz) (L)                   |
|  | 10x19cm (4x7.5")(S)<br>20x19cm (8x7.6") (L)          |

## FIELD DRESSING





## WILDLIFE™ INSECT REPELLENT





Wildlife insect repellents provide protection against mosquitos, gnats, midges, horse flies, ticks, tsetse flies

Deet 40% citrepiel 0.1%

Available as a **compact handy stick**  
**Long lasting - up to 10 hours**

Sold in an attractive display box of 24 units

|   |                 |
|---|-----------------|
| Code  | CL127           |
|  | 25g (0.8oz)     |
|  | 8cmx2cm (3"x1") |



Opening the sealed packaging lets oxygen react with the bag. Within a minute they release constant heat

Typically these packs are used for comfort, increasingly however, they are used in rescue operations where a survivor is trapped in a cold or exposed place

40 per box

Max temperature: 50°C to 65°C

Duration: 20 hours

|   |                 |
|---|-----------------|
| Code  | 40 pack: CL280  |
|   | 572g (20oz)     |
|  | 13x9cm (5x3.5") |

up to  
**20 hrs**  
of heat

## BODY WARMERS



## HAND WARMERS (X2)



Hand warmers work within a minute to instantly warm hands when necessary.

40 pairs per box

Max temperature:  
57°C to 70°C

Duration: 7 hours

|   |                    |
|---|--------------------|
| Code  | 40 pack:<br>CL281  |
|  | 25g<br>(0.8oz)     |
|  | 8cmx2cm<br>(3"x1") |

BCB shark repellent contains a chemical and a thick black dye that repels and disorients sharks

When tested by the US Navy BCB's shark repellent was the only product to achieve any success in repelling sharks

Since then BCB's shark repellent has been **used by Navies worldwide** as their **approved shark repellent**

When this foil packed sachet is squeezed in water, the **crystalline acetate produces a dense black cloud**

The inner bag has an attachment cord so it can be **kept close to your body**

This **NATO approved** product is used in life rafts and for airborne survival packs



|   |                       |
|---|-----------------------|
| Code  | MM208                 |
| NATO  | NSN: 6850-99-220-3539 |
|  | 115 grams (4oz)       |

## SHARK REPELLENT



COOKING

HYGIENE

SURVIVAL

CAMO

CAMP

CLOTHING

MEDICAL

TOOLS

SPECIAL



# KNIVES

Egress through the Plexiglas of a chopper. Plus, the LMF II does a slick job cutting firewood and building shelter.

Features:

- 2 Leg Straps
- Sheath
- MOLLE Compatible

|   |   |
|---|---|
| Code  | <b>CM0134</b>   |
|  | (w/ Sheath): 688g (24oz)<br>(w/o Sheath): 330.8g (11oz) |
|  | 26.8cm (10.59")<br>Blade: 12.3cm (4.84")                |

## LMF II INFANTRY FIXED BLADE KNIFE



Restricted sale item

## DMF MANUAL KNIFE

Semi-Serrated Tactical Blade  
With Modified Clip Point

Ambidexter Trous  
Wedge Lock

Thumbstud for One-Hand Opening

Lanyard Ring





Restricted sale item

A small, handy and sharp knife with several features, as seen above.

Easy to transport and can be opened with one hand

Dual thumb studs enable it to be opened neatly, with the blade "snicking" open, where it is held securely by a wedge lock - a simple ambidextrous slide release.

|  |   |
|--|---|
| Code   | <b>CM902</b>  |
|  | 737g (25.9oz)   |
|  | 21cm (8.2")<br>Blade: 9cm (3.5")<br>Closed: 12cm (4.7") |



## GATOR JR.



Restricted sale item

A short, tough, easily packable machete

The two-sided blade has both a fine edge for hacking through the jungle and a serrated edge for rough-cutting

Low-profile, its the perfect lightweight machete



Tactile rubber grip

Fine edge and saw blade

Riveted, nylon sheath included

**Head:** high carbon steel



**Handle:** gator-grip

|  |   |
|--|---|
| Code   | <b>CM0135</b>                           |
|  | 405g (14.30oz)                          |
|  | 47.6cm (18.75")<br>Blade: 27cm (10.75") |

Has a 15-inch fine-edge blade on one side and an 18-inch high performance saw blade on the other

Tactile rubber grip

Forged of high-carbon stainless steel

|   |                                     |
|---|-------------------------------------|
| Code  | <b>CM135</b>                        |
|  | 510cm (18oz)                        |
|  | 65cm (25.7")<br>Blade: 45.7cm (18") |

## GATOR MACHETE



Restricted Sale Item



Riveted, nylon sheath included

Fine edge and saw blade

Handle: Gator-Grip  
Head: High Carbon Steel

## FREESCAPE CAMP SAW



|   |   |
|---|---|
| Code  | <b>CM116</b>  |
|  | 433 grams   |
|  | Overall: 37.3x16.7x2.8cm (14.6x6.5x1.1")<br>Closed: 35x4.5x2.8cm (13.7x1.7x1.1")<br>Blade: 30.5cm (12") |

Robust folding saw

Perfect for travelling and camping

COOKING

HYGIENE

SURVIVAL

CAMP

CAMP

CLOTHING

MEDICAL

TOOLS

SPECIAL



# SHOVELS/SAWS

“A high quality shovel, lightweight and extremely strong. It is the premium size and weight. It has an extremely robust composition which could withstand excessive damage.” - Military trial report

When tested to destruction this shovel could not be broken

**Blade** - Made from hardened boron steel

**Shaft** - Drop profile cold formed welded precision tube

|   |                  |
|---|------------------|
| Code  | <b>CM0077</b>    |
|  | 1.6 kgs (3.5lbs) |
|  | 94cm (37.6")     |



## GENERAL PURPOSE SHOVEL

## GORGE FOLDING SHOVEL



The Gorge is lightweight and packable for back-country camping and hiking.

Nylon draw string bag included.

Easy-to-use push button slide mechanism

Hammer feature at base, great for hammering tent stakes



Nylon drawstring bag for easy transport

Small, compact size

Glass-filled Nylon Handle

Pick designed for use on hard packed ground

Sheath: Nylon bag

|  |  |
|--|--|
| Code   | <b>CM0064</b>                                |
|  | 794g (28.0 oz)                               |
|  | 41.9 cm (16.50")<br>(Closed) 23.5 cm (9.25") |

This shovel is perfect for clearing snow. It is robust and compact enough to carry around.

Strong, yet lightweight material.

Handle slides down to make storage easier.



|   |  |
|---|--|
| Code  | <b>CM157</b>   |
|  | 476 grams (16.8oz)   |
|  | Folded: 45x22.5cm (17.7x8.9")<br>Open: 65x22.5cm (25.6x8.9") |

## TELESCOPIC SNOW SHOVEL





## COMMANDO LIGHTWEIGHT WIRE SAW



Wrist Loops

## COMMANDO ORIGINAL WIRE SAW



Metal ring handles

Our popular patented wire saw now comes in two versions!

"The No1 choice commando wire saw"

A tightly woven (8 wire) **stainless steel** saw. Lightweight, versatile, robust and extremely strong.

"Ideal for an escape and evasion kit"

- With swivels and split rings
- **Cuts wood and plastic**
- Can be made into a **bow saw**



### The original and still the best wire saw

Can be used for escape and evasion  
Will cut wood, plastic and bone  
Can still be made into a bow saw  
Two handle styles - Wrist loops and metal rings

**The new version with wrist loops allows the saw to be used more comfortably and for longer in more demanding conditions.**

Can also be used to cut branches overhead:



|   |   |
|---|---|
| Code  | <b>CM020 (Original)</b><br><b>CM020A</b>                |
| NATO  | NSN-5110-99-456-2156 (Original)<br>NSN-5110-99-565-2549 |
|  | 10 grams (0.35oz)                                       |
|  | 58cm (23")  |

## POCKET CHAIN SAW



A **pocket sized, heavy-duty survival saw** made from riveted sections of band-saw style blade

It will **cut anything** from a thin branch to a large trunk comparatively easily

### Bi-directional cutting

Tapered teeth prevent blade sticking whilst cutting

Can be **thrown over high branches** for cutting above head height



Useful for **survival, wood clearing, travelling and gardening**

**Fantastic performance** for its size

Two string loop handles



Pocket Chain Saw **fits into a small pouch** (supplied)

|  |                      |
|--|----------------------|
| Code   | <b>CM023</b>         |
| NATO   | NSN-5110-99-565-2549 |
|  | 30g (1oz)            |
|  | 82cm (32.3")         |

COOKING

HYGIENE

SURVIVAL

CAMO

CAMP

CLOTHING

MEDICAL

TOOLS

SPECIAL



# IED KIT

## PERSONAL IED AND MINE EXTRACTION KIT (PMEK)



A compact lightweight kit. Designed for all people (and vehicles) to carry, at all times when travelling in an area of country where mines or IEDs may be lurking.

**This kit could save your life!**

The PMEK comprises of:

- A non-magnetic scraper to remove carefully, and from a distance, any loose earth covering the device
- A non-magnetic mine prodder of varying lengths to suit, up to 40 cm (16 inches) long. This is pointed and strong to penetrate most hard compacted ground
- 25 coloured marker pegs to clearly pinpoint the location of any device; or cleared ground
- 30 small chemical light sticks for night marking which can be clipped into the marker pegs
- An aid-memoire on mine field marking, and prodding techniques
- A trip wire feeler

All packed in a neat MOLLE belt pouch

|   |                                   |
|---|-----------------------------------|
| Code  | CK005                             |
| NATO  | NSN-1385-99-250-2178              |
|  | 420 grams (15 oz)                 |
|  | 16 x 8.5 x 6cm (6.3 x 3.3 x 2.4") |

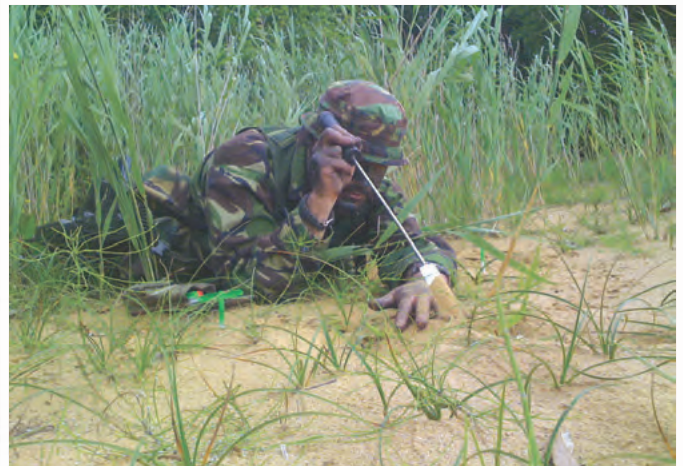



# TAPES



## FABRIC CAMO TAPE



Multi Terrain Pattern



Extremely strong, cotton based adhesive tape

An excellent temporary repair for your clothing, tent or bergen

|   |                  |
|---|------------------|
| Code  | CL1523           |
|  | 52 grams (1.8oz) |
|  | 10 meters (32ft) |

Versatile, pocket-sized tape  
Ideal for running repairs & patching-up webbing

Protects and reinforces areas  
Available in fabric, vinyl & gaffa-tape varieties

|  |                                |
|--|--------------------------------|
| Code   | CL1526                         |
|   | 118 grams (4.2")               |
|  | 48mm x 5 metres (1.9 x 196.9") |



## GAFFER TAPE



This amazing self-infusing tape literally fuses to itself with a permanent bond after approximately one minute

Stretching the tape activates the silicone and when bound to itself it has a tensile strength of 700 psi and is watertight and airtight

Can be applied when wet and can even be used as an emergency fan belt

|   |  |
|---|--|
| Code  | CL1527<br>CL1527A (In padded envelope) |
|  | 90 grams (3 oz)                        |
|  | 8.9x8.9x3.8cm (3.5x3.5x1.5")           |

## SILICONE REPAIR TAPE





FOR A  
"PERMANENT"  
BOND

A strong, reinforced tape

5 metres (15 feet)

Compact

Excellent for everyday repairs

|   |                 |
|---|-----------------|
| Code  | PB630           |
|  | 58 grams (2 oz) |
|  | 5 meters (197") |

## DUCT TAPE







# ACCESSORIES

## COMBINATION PADLOCK



Heavy duty, aluminium combination padlock available in 2 sizes

|   |   |
|---|---|
| Code  | <b>CJ560 (Small)<br/>CJ559 (Large)</b>      |
|  | S: 64 grams (2.24oz)<br>L: 125 grams (1.5") |
|  | S: 2.5cm (0.9")<br>L: 4cm (1.5")            |

## KEY PADLOCK



Heavy duty aluminium padlock with 3 keys

|   |              |
|---|--------------|
| Code  | <b>CJ557</b> |
|  | 181 grams    |
|  | 40mm         |

## 6" MAP READING PROTRACTOR

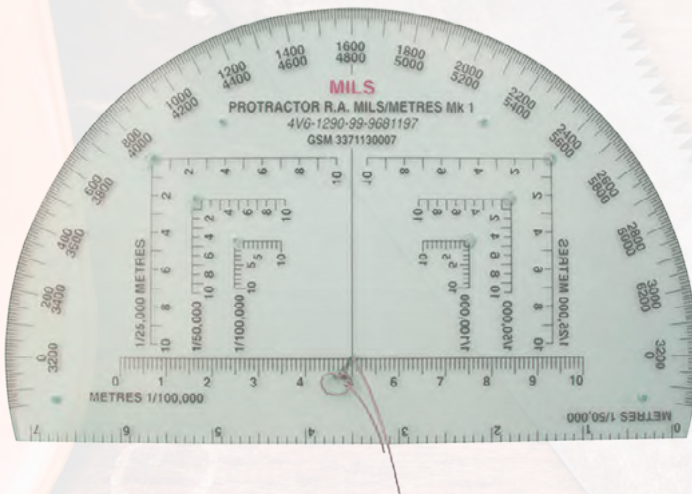

Accurate 6" R.A mils map reading protractor

This is a **high quality accurate angle measuring device**. Useful for **map reading and outdoor pursuits**.

Supplied with **hard coating and string**



Graduations are in mils not degrees

|  |                         |
|--|-------------------------|
| Code   | <b>CD032</b>            |
| NATO   | NSN 1290-99-9681197     |
|  | 15 x 9.5cm (5.9 x 3.7") |



Stainless steel

2 pieces with black rubber edge

|   |                              |
|---|------------------------------|
| Code  | <b>PB510</b>                 |
|  | 31 grams                     |
|  | 50x30x1mm<br>(1.9x1.2x0.03") |

## DOG TAGS





## ELASTICATED BUNGEEES



**Heavy duty**

**Strong rubber coated metal hooks**



**4 per pack**

**Multi-purpose and robust**

**Essential around the camp**

**Different colours available:**

- Olive green
- Orange/yellow

|   |  |
|---|--|
| Code  | CM031   |
|   | CM031D  |
|  | 1 metre (3ft)  |

**Strong and long with breaking strain of approx 50 kilos**

**15 metres (50 feet) length**

**Protective wear resistant sheath**

**Braided inner cord can be used as fishing line or for sewing**

**Olive paracord useful to soldiers and woodmen alike.**

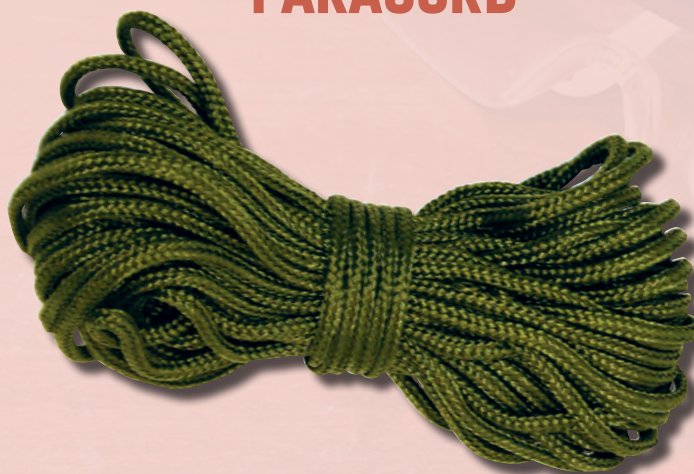

|   |                  |
|---|------------------|
| Code  | CM030            |
|  | 15 metres (50ft) |

## PARACORD



**Small, strong, and an essential part of your travelling tool kit.**





|  |                      |
|--|----------------------|
| Code   | RK011                |
| NATO   | NSN-8530-99-463-6946 |
|  | 2g (0.1 oz)          |
|  | 22 x 40 x 0.04mm     |

## SINGLE EDGED RAZOR BLADE



**Small, strong, and an essential part of your travelling tool kit.**



|  |                      |
|--|----------------------|
| Code   | RK011                |
| NATO   | NSN-8530-99-463-6946 |
|  | 2g (0.1 oz)          |
|  | 22 x 40 x 0.04mm     |



# MULTI TOOLS

## SEWING KIT



All items necessary for running repairs to clothing, housed in a **strong zippered pouch**

Available in **black** and **multicam**



- 3 Lengths of thread
- Folding scissors
- Safety pins
- Needles
- Buttons and more

|   |                                    |
|---|------------------------------------|
| Code  | <b>CJ135A</b> ●<br><b>CJ135M</b> ● |
|  | 10 x 7 x 2cm                       |
|  | 43grams                            |

Hanging up side down and held in with a seat belt or some other tough nylon strapping? No worries. Cutting through the webbing will be like using a hot knife on soft butter. Simple as that.

Cuts through nylon straps and seat belts in seconds

Blade: 420HC Stainless steel black

|   |                                      |
|---|--------------------------------------|
| Code  | <b>CM0147B</b> ●<br><b>CM0147C</b> ● |
| NATO  | NSN 1290-99-9681197                  |
|  | 64g (2.25oz)                         |
|  | 11.2cm (4.4")                        |

## STRAP CUTTER





## POCKET SURVIVAL TOOL



12 in 1 multi-tool in a travel-friendly pouch

Its small size and light weight means it can fit comfortably in a pocket ready for when it is needed

Never get caught out without the right tool again

|   |                                |
|---|--------------------------------|
| Code  | <b>CM024B</b>                  |
|  | 270 grams (11oz)               |
|  | 85x55x1.2mm<br>(3.3x2.1x0.04") |



## FLASHLIGHT MULTI-TOOL



**Strong, easy and quick to open**



The small LED flash light in the pliers head is ideal for **night time emergencies and low-light conditions**

**Comfortable contoured handle**

**2 Batteries included - CR1220**

**Durable nylon belt pouch included**

- Needle Nose Pliers (Sprung Loaded) • Wire Cutters • LED Torch • Can Opener • Philips Screwdriver • Bottle Opener • Large Flat Screwdriver • Serrated Knife Blade • Sharp Double Toothed Saw • Smooth Edge Blade • Fishing Hook Remover • Serrated Knife Blade • Medium Flat Screwdriver • Small Flat Screwdriver •

|   |  |
|---|--|
| Code  | <b>CM648</b>                               |
|  | 270 grams (11oz)                           |
|  | Open: 17.7cm (6.9")<br>Closed: 10cm (3.9") |

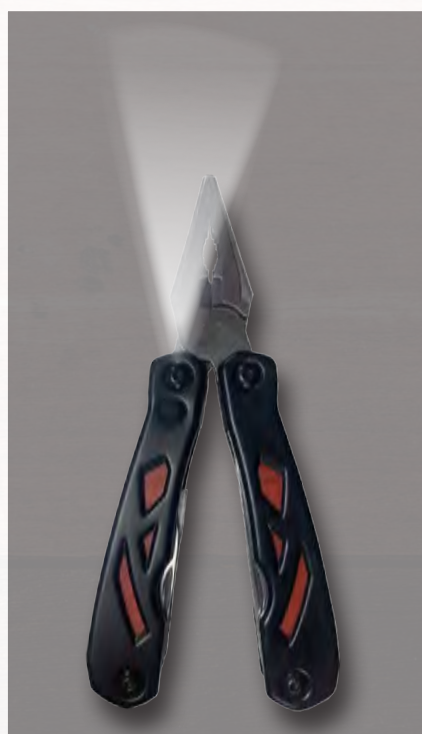

COOKING

HYGIENE

SURVIVAL

CAMO

CAMP

CLOTHING

MEDICAL

TOOLS

SPECIAL



# LOCATION

Fully waterproof and fully transparent, so you can view your map from both sides in any weather conditions

The neck strap lets you keep your hands free



Small holes in the corners make it possible to attach the map case to your gear

Suitable for digital maps and A4 maps

Winter use - flexible in temperatures down to -20°C

Closure - quick and easy closure system

Temperature operating range: -20°C to +60°C



|   |               |
|---|---------------|
| Code  | CM079         |
|  | 64g (2.25oz)  |
|  | 11.2cm (4.4") |

## CARRY DRY MAP CASE



Heavy duty map case, with external pen pockets

Large window pocket for map secured with a zip fastener

|   |                       |
|---|-----------------------|
| Code  | CD1422M               |
|  | 235 grams (8oz)       |
|  | 60 x 40cm (24" x 16") |

Clip attachment, and Velcro closed



## PATROL COMMANDER'S MAP CASE



A base plate compass, containing a magnifying glass, ruler and scales for 1:25000 and 1 mile to 1 inch



The liquid filled compass rotates within the base

|   |                        |
|---|------------------------|
| Code  | CK602                  |
| NATO  | NSN-6605-99-501-14968  |
|  | 53g (2oz)              |
|  | 15.5 x 4.5cm (6" x 2") |

Nylon lanyard included

Stencil holes for adding map symbols

## MAP READING COMPASS





An extremely compact and accurate button compass

Features a rotating bezel and a clear acrylic base plate

Nylon lanyard included

Oil filled and cushion mounted

Luminous dial

|   |                   |
|---|-------------------|
| Code  | CK315             |
|  | 8g (0.28oz)       |
|  | 3 x 5cm (1" x 2") |

## MINI COMPASS II





## EXPLORER BUTTON COMPASS



An exceptionally robust, oil filled, pressurised military approved compass which features in most of our survival kits

Designed for escape and evasion

Load tested to 24kg  
(52.9 lbs)



|      |                      |
|------|----------------------|
| Code | <b>CK311</b>         |
| NATO | NSN-6605-99-127-9239 |
|      | 2g (0.07oz)          |
|      | 1.3cm (0.51")        |

The "full-size" base plate compass for experienced navigators.

The Expedition 4 is used by many defence forces around the world

Compass housing made from Dryflex™ - rounded base plate

Patented red/black orienting lines

Luminous markings - enables night navigation

Hole for marking positions on map

Built in magnifier for detailed map reading

|      |                                   |
|------|-----------------------------------|
| Code | <b>CK406</b>                      |
|      | 74 grams (2.6oz)                  |
|      | 23.4x11.4x2.4cm<br>(9.2x4.5x0.9") |

## EXPEDITION 4 COMPASS



## 3 IN 1 KARABINER, COMPASS + THERMOMETER



Metal case

Zinc alloy

Liquid filled with luminous dial for easy reading at night

Please note: Not to be used for climbing

|      |                          |
|------|--------------------------|
| Code | <b>CK310</b>             |
|      | 30 grams (1.05oz)        |
|      | 7x3x1.5cm (2.7x1.1x0.5") |

Mils and degrees

A highly useful and resourceful compass for artillery; target acquisition and command posts.

Once activated by daylight/flashlight it will give up to 4 hours of light.

6400 mils on the graduation ring and 6400 mils + 360 degrees on the sighting scale.

Accuracy:  $\pm 0,5^\circ$  (8.9 mils)

Altitude use: 5000m @ -15 °C

Waterproof

|      |                  |
|------|------------------|
| Code | <b>CK401</b>     |
|      | 9 grams (0.3oz)  |
|      | 126 x 60 x 16 mm |

## SILVA PRISMATIC COMPASS 55



COOKING

HYGIENE

SURVIVAL

CAMO

CAMP

CLOTHING

MEDICAL

TOOLS

SPECIAL



# LOCATION

This innovative mirror is **lightweight, robust and approved for marine and military use**

It is **highly reflective**, tested out to a **9 mile range**, for the small mirror and longer for the life craft/lifeboat larger mirror

Designed for **one handed operation**

- Accurate and effective
- Floats
- Robust
- Quick and easy to use
- Instructions printed on reverse side

**RAF Trials Report: Observers at the target noted the bright white flash of the BCB heliograph immediately in all cases.**

**The trials subjects found the BCB heliograph easier to operate than RAF heliograph.**

|   |   |
|---|---|
| Code  | <b>RP314 - Compact</b><br><b>CK324 - Advanced</b>                   |
| NATO  | (Compact): NSN-6350-99-613-9818<br>(Advanced): NSN-6350-99-613-3083 |
|  | Compact: 5x5cm (2x2")<br>Advanced: 10x10cm (4x4")                   |
|   | Compact: 100 grams (3.5oz)<br>Advanced: 200 grams(7oz)              |

## SIGNALLING MIRROR-HELIOGRAPH



Can be seen from miles away



+44 (0) 29 2043 3700

www.bcb.in.com

111



## STAINLESS STEEL HELIOGRAPH

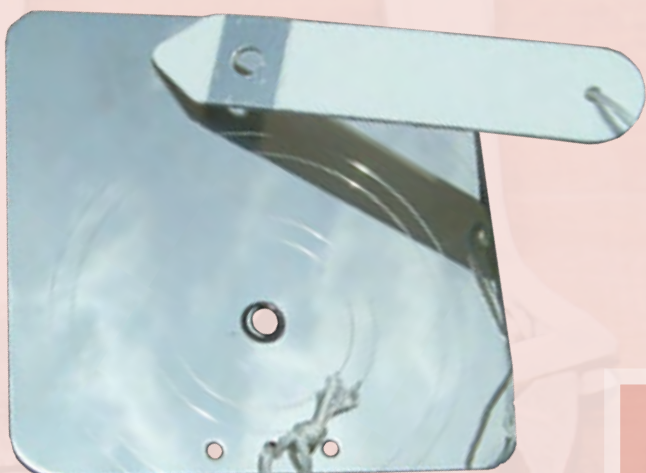

Stainless steel

Highly reflective

Available in 2 sizes - 2" or 4"

Very tough and durable

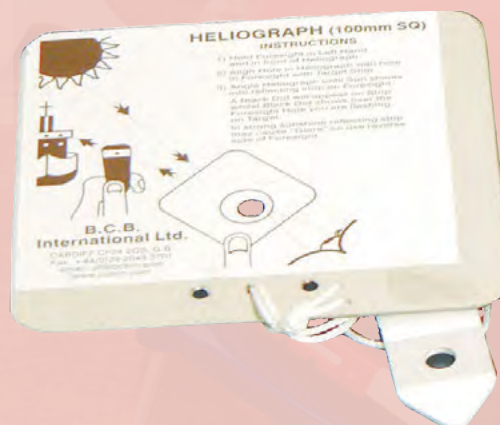

|   |  |
|---|--|
| <b>Code</b>   | <b>MF600 - Compact</b><br><b>MF601 - Advanced</b>      |
|  | Compact: 5x5cm (2x2")<br>Advanced: 10x10cm (4x4")      |
|  | Compact: 100 grams (3.5oz)<br>Advanced: 200 grams(7oz) |

## DISTRESS WHISTLE



Bright orange emergency distress whistle. Produces a high decibel noise from low air input.

› Side clip › SOLAS approved

|   |                  |
|---|------------------|
| <b>Code</b>   | <b>CK312</b>     |
| <b>NATO</b>   | 4220-99-1209470  |
|  | 2x5cm (0.75"x2") |



## HOWLER WHISTLE



An incredibly loud whistle  
Compact with no moving parts  
British made whistle

Used also by mariners and sports persons

SOLAS approved

|   |                         |
|---|-------------------------|
| <b>Code</b>   | <b>CK316</b>            |
|  | 18.1 grams<br>(0.6oz)   |
|  | 2 x 5cm<br>(0.75" x 2") |

COOKING

HYGIENE

SURVIVAL

CAMO

CAMP

CLOTHING

MEDICAL

TOOLS

SPECIAL



# LOCATION MARKER BALLOON

## A GROUND TO AIR SIGNAL BALLOON DESIGNED BY THE MILITARY FOR THE MILITARY

- **New and improved**
- Quickly deployed in under 2 minutes
- **Can be operated by one person within minutes**
- Reusable
- Lightweight and safe to use
- **Lightweight carbon fibre helium cylinder**
- Large (over 1 metre) bright balloon
- **Can be seen over 10 miles away**
- Day or night time visible. Attach a chemical light (two supplied)
- **Radar reflective**
- Uses inert helium gas to inflate 136 litre Radar Reflective balloon
- **Will float high above any jungle or forest**
- Two chemical light disks (supplied) can be attached to both sides of the balloon giving at night an excellent signal, especially if the pilot is wearing NV goggles
- **75 metre (250 feet) strong kevlar tether**
- The balloon will stay aloft for many days





- The balloon has an excellent lifting capacity and can take up approximately 90 gms (i.e. a radio antenna) above the canopy
- The foil balloon gives a large radar reflective signature (over 10 metres)**
- Can be quickly used to mark your Drop Zone position or if in need of rescue
- Can be pulled back down and released back up as required**
- Very effective in other distress environments, e.g. maritime, desert and woodland



Helium cylinder



Balloon

Strong line

Durable carry bag

See just how well it works:



|   |   |
|---|---|
| Code  | CK409H  |
| NATO  | NSN-4240-99-366-5580  |
|  | Approx. 900 grams (31oz)  |
|  | Packed: 39x25x12cm (15x9.8x4.7")<br>Open: 119x66cm (46.8x25.9") |

COOKING

HYGIENE

SURVIVAL

CAMO

CAMP

CLOTHING

MEDICAL

TOOLS

SPECIAL



# LIGHTING

High, low and strobe modes

Adjustable beam - wide or focused

Light source cree LED light chip

Slide focusing head patented slide function

Over **100 metres beam distance**

High grade aluminum alloy body

End cap switch easy access recessed rear mount power button

Removeable pocket clip



Rubberised tooth guard

Waterproof

Lumens: **130**

Runtime: **5 hours**

Batteries: **1 x AA** (battery not included)

|   |   |
|---|---|
| Code  | <b>CE024</b>                            |
|  | 53.8 grams (1.8oz)                      |
|  | 10.5cm (4") adjustable to 11.7cm (4.6") |

## COMBAT ZOOM FLASHLIGHT



## LIGHT STICKS X 2



Excellent for map reading and in emergencies

Long lasting - up to 12 hours

Next to no storage space

Red, white or green (other colours available)

|   |                        |
|---|------------------------|
| Code  | <b>CE570(R●/W○/G●)</b> |
|  | 64g (2.25oz)           |
|  | 11.2cm (4.4")          |

Durable and adjustable

Beam spot to flood capability, and bright CREE technology.

This dependable **180 lumen** light has **three modes** and offers no dead spots in the beam to give the user a **clear consistent beam**.

- Pull zoom for flood to spot operation
- 3 Modes: High, Low, Strobe
- CREE Bulb Technology
- Batteries included (3x AAA)

|   |               |
|---|---------------|
| Code  | <b>ADV003</b> |
|  | 72g (2.25oz)  |

## HOT SHOT MINI HEADTORCH





## FFLAM TORCH MKII



### A new, lighter-weight waterproof torch

The rubberised outer coating protects itself from the worst of maritime environments

Fully waterproof and approved flashlight

Uses 2 x AA batteries (supplied)

With morse code signal button



Strong and impact resistant

Approved to ISO 18813

Over 100 candela after 5 hours

Supplied with a replacement LED head contained in a separate case

Batteries: 2 x AA batteries (supplied)

|  |                               |
|--|-------------------------------|
| Code   | CE576                         |
|   | 115 grams (4oz)               |
|  | 16x4.5cm (6.2x1.7") head dia. |

## MICRO FLASHLIGHTS





This small key-ring size LED will give a continuous light for up to 10 hours if required, or signalling ability to over a mile

Comes complete with a battery fitted

Small and robust



|   |                               |
|---|-------------------------------|
| Code  | CE057 ●<br>CE014 ○<br>CE016 ● |
|  | 5.5 grams (0.25oz)            |
|  | 4x2.5x0.6cm (1.5x1x0.25")     |

COOKING

HYGIENE

SURVIVAL

CAMO

CAMP

CLOTHING

MEDICAL

TOOLS

SPECIAL



# NON-LETHAL

---

## BOAT STOPPING SYSTEMS (BSS)

BCB has many years of experience producing non-lethal Boat Stopping Systems (BSS). These three variations each use a pneumatic launcher that fires an arrestor line across the bow of a suspect or intruding vessel.

This provides a **non lethal, quick, easy and reliable** means of stopping vessels. The BSS are **unique, patented** maritime defence systems which are non lethal, **100% effective**, simple to use and **extensively tested**.

### THE LINE ARRESTOR SYSTEM:



The arrestor line system is simple and effective

Each system fires a floating Dynema or Spectra line with a sea anchor at both ends.

The line and sea anchors are launched, and the sea anchors deploy.

The floating line catches on the rudder or the propeller shaft. The sea anchors inflate and create many tons of drag to stop the target vessel.

① The line and sea anchors are launched in a streamlined container (the munition)

② The floating line captures the cavitation plate/anti-ventilation plate on outboard or inboard/outboard motors, or the boat's rudder etc.

③ The sea anchors deploy and inflate to create many tons of drag to slow the target vessel to a stop in seconds.

④ The line normally does not foul the propeller or damage the vessel.





## CHOOSE FROM STRAIGHT LINE OR V-SHAPED LAUNCHER:

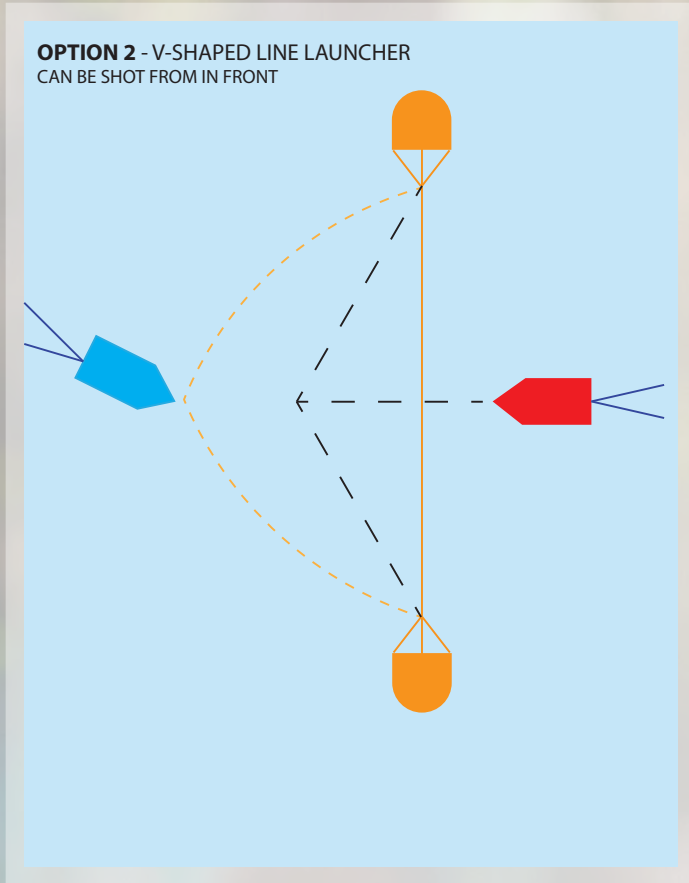
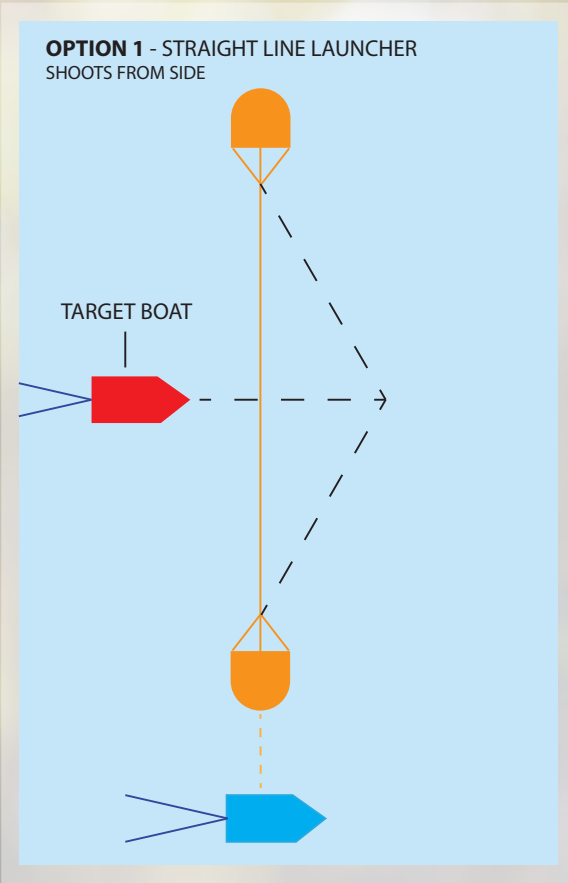

Both Buccaneer and Sea Stinger can be given a **unique capability** by mounting two barrels on a common manifold in a V configuration so that the launcher can **fire both ends of the floating line at once**, thus enabling the line to be projected perpendicular to the firing point.

This is effective in a **head-on encounter scenario** where a line can be laid down in front of the target, for **protecting an asset against an incoming threat** or laying down a barrier behind the launching vessel.

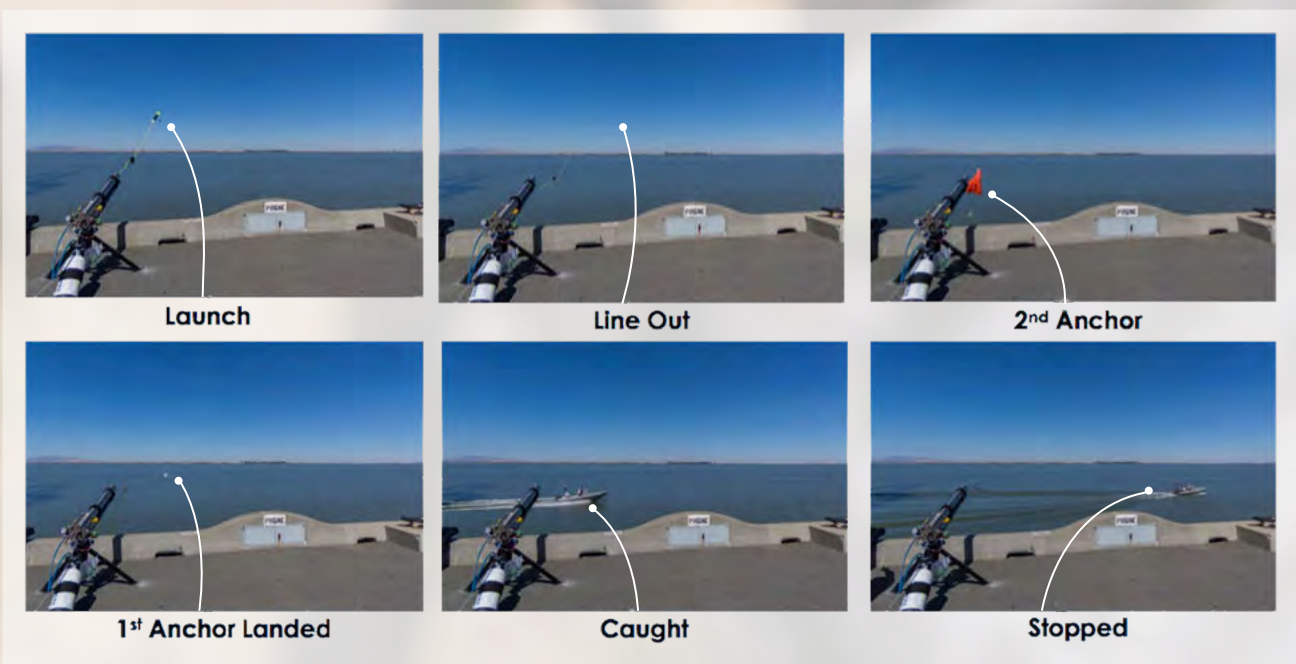

COOKING

HYGIENE

SURVIVAL

CAMO

CAMP

CLOTHING

MEDICAL

TOOLS

SPECIAL



# NON-LETHAL BOAT STOPPING SYSTEMS (BSS)

The BSS in action:



Three variants - Barracuda, Buccaneer and Sea Stinger:

| FEATURE                | BARRACUDA (HAND-HELD)  | BUCCANEER (SHIP BORNE)  | SEA STINGER (PORT OR LARGER VESSEL)   |
|------------------------|--|---|---|
| Barrel diameter        | 5" (125mm)   | 5" (125mm)  | 7" (175mm)  |
| Maximum range (approx) | 40yds (36m)  | 200yds (200m)   | 437yds, 400m (line)<br>328yds, 300m (net)   |
| Typical line length    | 40yds (36m)  | 100yds (100m)   | 218yds, 200m (line) 100m (net)  |
| Typical barrel length  | 24" (50cm)   | 48" (1.2m)  | 48" (1.2m)  |
| Max operating charge   | 11bar (160psi)   | 40bar (600psi)  | 40bar (600psi)  |
| Total weight           | 28.6lbs (13kg)   | 72lbs (33kg)  | 430lbs (195kg)  |
| Dimensions             | 6" x 52" (15cm x 130cm)  | 47" x 11" (117cm x 27cm)  | 59" x 23" (147cm x 57cm)  |
| Suggested application  | For hand-held use on or off shore.<br>Use in confined waterways. | This medium launcher can have a single or twin V shaped barrel fitted. For use on all sizes of vessels from RIBS to capital ships to merchant vessels. Can be used to fire a line to ship to ship or ship to shore. | For closing quickly a port, harbour or estuary or for non lethal protection of a navy, coastguard vessel or oil rig.<br>To protect any maritime assets. |

Comparitive diagram of the three BSS variants:

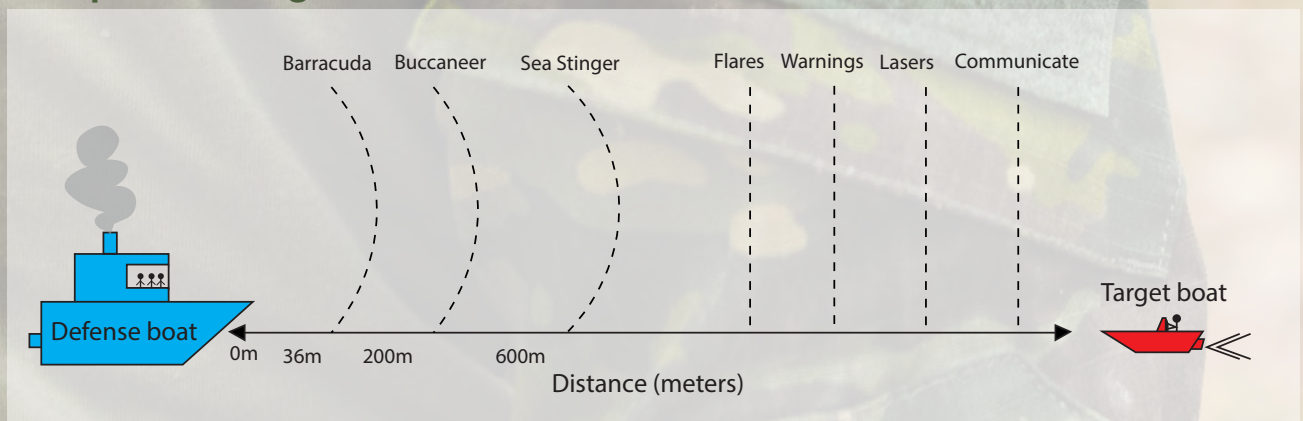



1

# BARRACUDA

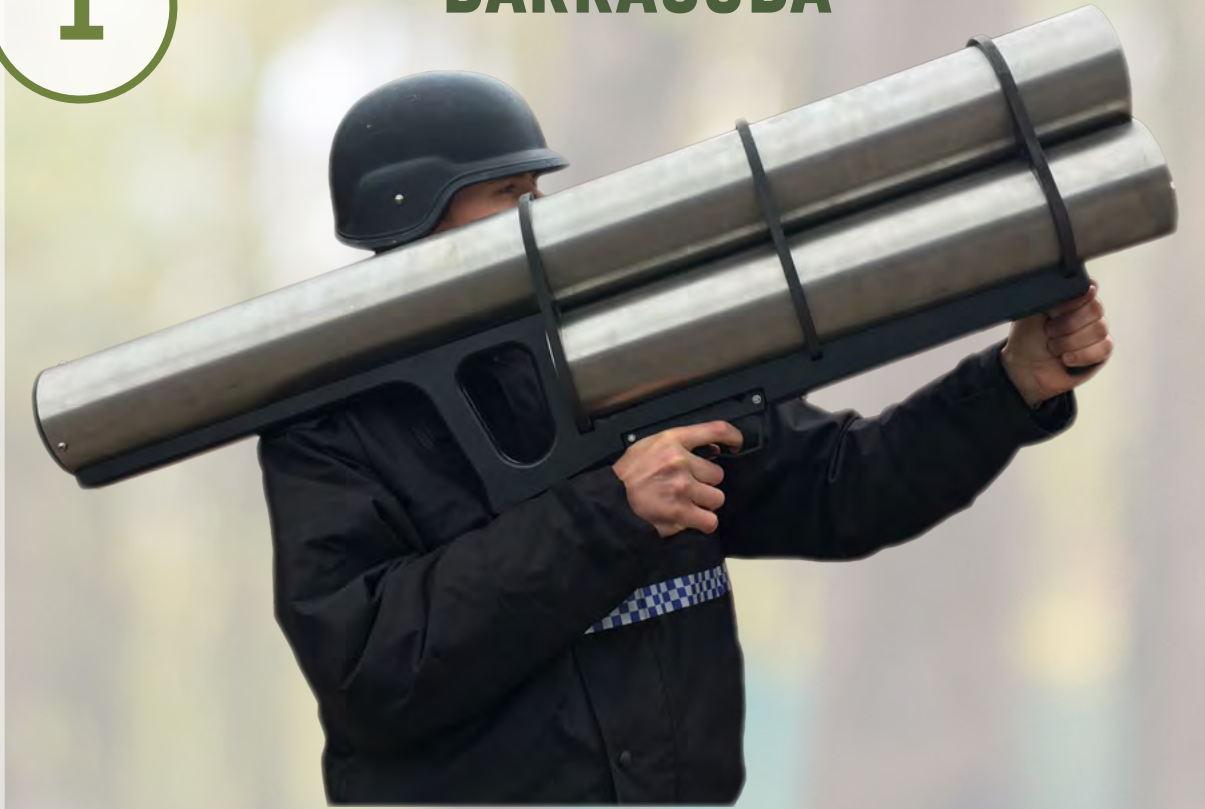

A hand-held device capable of launching a 36 metre (40 yard) arrestor line and two 3 ft (1m ) sea anchors.

Operates at a low pressure of 150 pounds per square inch

Works in a variety of sea states



Ideal for close-in interception

Comes in carrying case with two munitions

|      |                   |
|------|-------------------|
| Code | BARR001           |
|      | 13kg (28.6lbs)    |
|      | 15x130cm (6"x52") |

Watch our short BSS video playlist:



SPECIALIST

COOKING

HYGIENE

SURVIVAL

CAMO

CAMP

CLOTHING

MEDICAL

TOOLS

SPECIAL

120



# NON-LETHAL BOAT STOPPING SYSTEMS (BSS)

2

## BUCCANEER



In recent trials the buccaneer stopped a 3 ton boat at 25 knots in seconds



The Buccaneer KIS delivers projectiles designed to deter and disable small fast sea craft at extended range

With a range of up to 200 meters the Buccaneer KIS uses specialised payloads to lay **buoyant netting / line** for interdiction operations. The Buccaneer KIS is **extremely flexible** having a **360 degree rotation and depression and elevation of 45 degrees from horizontal**.

It can be operated remotely from the bridge or control room quickly and safely and uses **no explosive or pyrotechnics parts in its use**.

The Buccaneer can be loaded with alternative projectiles such as **high density smoke, flares, or buoyancy aids**.

### Projectiles to either:

Lay **netting over a wide area**

Lay a **buoyant line or lines**

Or to **entangle the assaulting crafts propeller**.

Dispense **airburst smoke** or an **irritant gas**

Dispense **multiple small projectiles** over a wide area - up to a 50 meter square - in a **scatter gun approach**



Control station for remote firing



### The projectiles:

**Non lethal** - like paintballs

**Less than lethal** - like squash balls

**Lethal** - like gravel or golf balls

### This provides a layered defence.

The lethality can be increased if the approaching craft is not initially deterred.

Alternatively, it can deploy:

**Survival items to a man overboard** like a single seat liferaft or buoyancy aids

**A rope line to shore for mooring**, or to another vessel for **towing**

|      |                             |
|------|-----------------------------|
| Code | BUC001                      |
| NATO | NSN:1095-99-993-1079        |
|      | 33kg (72lbs)                |
|      | 117cm x 27cm<br>(47" x 11") |

+44 (0) 29 2043 3700

www.bcbin.com

121





# SEA STINGER

3



The Sea Stinger is used as an 'Area Denial System' for large marine key point installations such as oil rigs, ports, estuaries or large cargo vessels that are vulnerable to acts of piracy or terrorism.

The 'big brother' of the Buccaneer, the Sea Stinger is able to deploy entangling net out to a range of **600 meters**

Recover the line or net and re-use it again and again

The Sea Stinger provides a non lethal deterrence and defence against incursions into vulnerable water ways and areas of sea. It is both simple to use and maintain.



Reloading is quick and easy, taking only two minutes

Dockside mounted or on board a ship

The largest of the three in the range

Stainless steel throughout



|   |                      |
|---|----------------------|
| Code  | BUC002               |
|  | 195kg (430lbs)       |
|  | 147x57cm (59" x 23") |

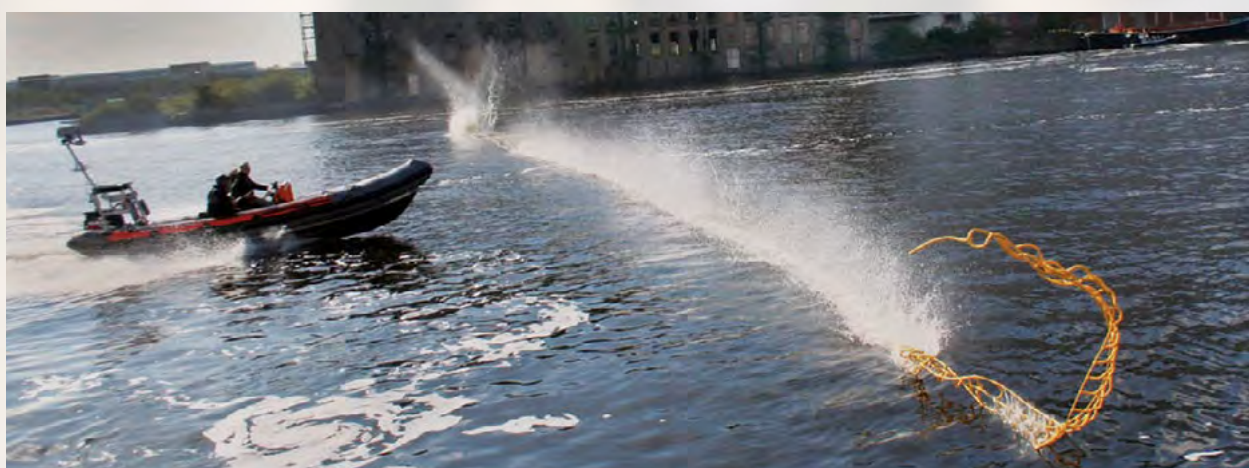

COOKING

HYGIENE

SURVIVAL

CAMO

CAMP

CLOTHING

MEDICAL

TOOLS

SPECIAL



# NON-LETHAL

## FRAMM



9  
Position  
Settings

The **FRAMM** is a **unique stock** that allows operatives to **comfortably use their weapons** while wearing a ballistic helmet with the visor fully lowered, ballistic visors or gas masks.





Left and right hand use

Easy to install and use

Patented

Folding

Lightweight

|   |                       |
|---|-----------------------|
| Code  | CL531                 |
|  | 400 grams<br>(14.1oz) |
|  | 210mm<br>(8.2")       |

**Nine position settings** ensure that it can **conform to any body and ballistic visor shape**

**Rubberised non-slip** weapon stock pad maximizes **comfort and firing stability**



+44 (0) 29 2043 3700

www.bcbin.com

123





## KANN

|                             |   |
|-----------------------------|---|
| Model Defence Ball Launcher | Rifled long barrel                                  |
| Material                    | High quality stainless aluminium                    |
| Safety                      | Barrel removable via pin                            |
| Size                        | 44 / 83 SP  |
| Action                      | One/Single  |
| Height                      | Butt Folded 19.5" (500mm)<br>Extended 27.5" (700mm) |
| Thickness                   | Butt Folded 3.6" (92mm)<br>Extended 2" (52mm)       |
| Weight                      | 5lb / 2.30kg  |
| Length Barrel               | 11" 280mm   |
| Rifled                      | 12 Right  |
| Accuracy                    | Within a 8"x8" square from 98ft                     |
| Sights                      | Fibre Optics  |
| Pontet                      | Oversized fingers passage                           |
| Quick Scoring               | 3-point system for quick scoring targets            |
| Load carriage               | 1 strap attachment                                  |

The KANN 44 CLR® is a new generation and innovative less-lethal launcher, which best meets today's challenges and operational requirements

Its design outperforms other launchers on the market on the quality of materials used as well as its accuracy thanks to its long rifled barrel 11"(28cm)





## FLEM

The FLEM® is a patented less-lethal ammunition for smooth barrelled 12 gauge shotguns

Its unique design delivers more accurate, safer and effective immobilisation of target than other less-lethal 12 gauge projectiles on the market

- Extremely accurate within a 30cm2
- Limits rebounding
- High visibility green or yellow
- Less lethal
- 20 meters
- High accuracy = less collateral damage

|   |                  |
|---|------------------|
| Code  | QA026            |
|  | 14 grams (0.5oz) |
|  | 52mm (2")        |

| FLEM 12 GAUGE    | Less-lethal ammunition    |
|------------------|---------------------------|
| Material         | Elastomer composite       |
| Caliber          | 12 Gauge                  |
| Diameter         | 0.7" (18mm)               |
| Length           | 2" (52mm)                 |
| Weight           | 0.5oz (14 gram)           |
| Cartridge casing | Plastic: 0.02oz (0.8gram) |
| Maximum speed    | 160m/s                    |
| Shooting range   | 20m                       |
| Accuracy         | 30cm2<br>20 meters away   |

|            |        |
|------------|--------|
| UN Number  | UN0012 |
| Risk Class | 1.4s   |

COOKING

HYGIENE

SURVIVAL

CAMO

CAMP

CLOTHING

MEDICAL

TOOLS

SPECIAL



# WALL BREAKER - NON EXPLOSIVE

The WBS (Wall Breaker System) is the high power launcher, capable of firing a 22kg projectile with sufficient force to punch through, non explosively, a double skin breeze block cavity wall.

The WBS can be mounted on a static location, such as critical infrastructure, vehicle mounted or manually wheeled into position



+44 (0) 29 2043 3700

www.bcbin.com



- **Non Lethal** - increasing the safety of building occupants
- **Extensively tested and engineered to the highest standards.**





- **Easy to operate and maintain**
- **Adaptable and flexible to your operational needs**
- **Can be recharged and loaded in seconds**
- **Low cost**
- **In service now worldwide with S.F., SWAT and Military units**

Watch it in action:



Fitted with a Recoil Mitigation System the WBS uses water or sand filled projectiles. Reduces collateral damage and increasing safety for building occupants: such as hostages or for search and rescue operations.

|   |  |
|---|--|
| Code  | WB05   |
| NATO  | NSN:1095-99-474-6909                                 |
|  | 102.5kg<br>(16 stone, 2lbs)                          |
|  | 66.5 (H) x 80 (W) x 101.5cm (D)<br>(26 x 31.5 x 40") |



COOKING

HYGIENE

SURVIVAL

CAMO

CAMP

CLOTHING

MEDICAL

TOOLS

SPECIAL



# RESCUE

## FIBRELIGHT CRADLE



A Maritime recovery system that can be operated by a single crew member.

The Cradle also serves as a **boarding ladder, scramble net and stretcher.**

The Fibrelight Cradle is **lighter, more compact and more versatile** than any comparable devices on the market.

Requires only regular inspections and minimal maintenance, so there is no requirement to pay for annual servicing.

The Cradle has been primarily designed for use by rescue craft, rigid inflatables, ship lifeboats and Marinas.



|   |                      |
|---|----------------------|
| Code  | <b>MF809</b>         |
|  | 5kg (11lbs)          |
|  | 1.3x3 metres (4ft3") |

The inflatable bridge with a difference  
Catamaran style 'footprints' offer **enhanced stability** on water

- **Easy portability**
- **Rapid inflation**, deployment and mobility
- Rapid extension 'link-up'
- Total stability air bridge
- Use for recovery or as a work platform.

| Code   |  |  (Capacity) |
|--------|---|--|
| MF0011 | 2 metres  | 200kg  |
| MF0012 | 3 metres  | 300kg  |
| MF0013 | 4 metres  | 400kg  |
| MF0014 | 5 metres  | 500kg  |
| MF0015 | 10 metres   | 1,000kg  |

## RESCUE BRIDGE

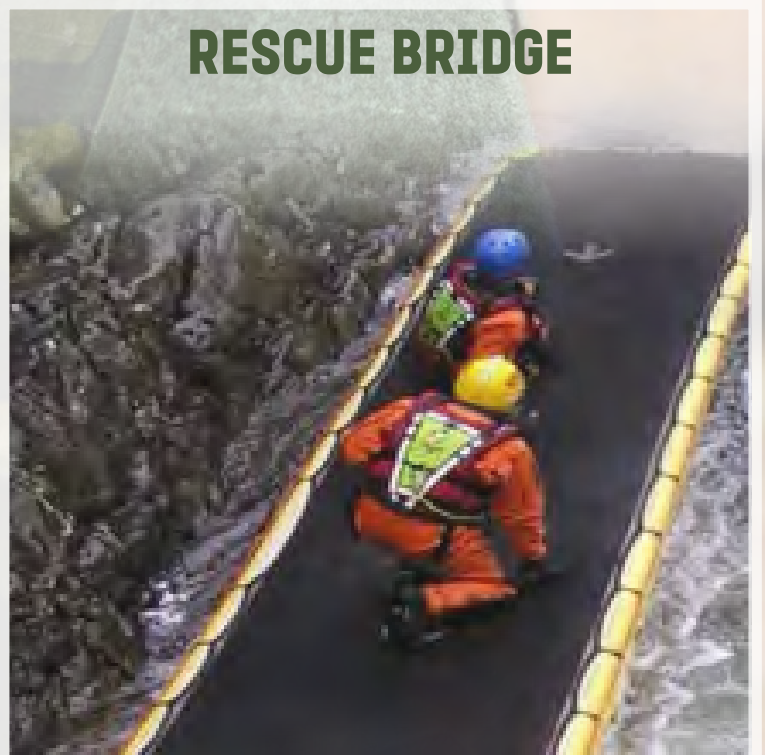



## FIBRELIGHT EMERGENCY LADDER

- This ladder can be carried and then deployed by a **single person in less than a minute**
- **Lightweight** and **straightforward** to use
- **Incredibly strong** - this ladder has been tested and approved for thermal ageing, weathering, UV light, oil resistance and practical performance
- Standard width of **600mm**, produced in lengths of **2 to 30 metres**
- **Orange or black**
- There are **no metal parts** and therefore is suitable for deployment on vessels or platforms with fire risks



SOLAS  
Approved

MCA  
Accepted

Portable

No Annual  
Servicing

Lightweight



|   |                                |
|---|--------------------------------|
| Code  | <b>MF807</b>                   |
|  | 25.96 kg (57.2lbs) (30 metres) |
|  | 2 - 30 metres (6ft6" - 98ft5") |



# RESCUE

## INFLATABLE RESCUE CUSHION

The Inflatable Rescue Cushion is ideal for rescuing persons when it is not possible to use a ladder. The unit is very fast to deploy and facilitates rapid evacuation. It is very stable and there is almost no bounce-back. The cushion always deforms towards the centre and it is easily transported whether packed or inflated.

The Inflatable Rescue Cushion comprises an inflatable frame which supports a high strength, flame retardant PVC coated fabric. Inflation is from a 300 bar air cylinder, the connection for which will be compatible with the brigade standard. Relief valves are fitted to prevent over pressure but the operating pressure of the tubular framework is sufficiently high to ensure extended service periods without topping-up. As the frame inflates air enters the cushion, which is divided horizontally into two chambers, through vents in the side walls. The force of a person landing on the cushion temporarily deforms it towards the centre. Air from the cushion (but not from the tubular frame) is forced out and so the impact is absorbed. On removing the person the cushion recovers its form within seconds.



The Inflatable Rescue Cushion can also be used to rescue pilots escaping from cockpit windows on burning aircraft or for aircraft without escape slides.

**Surface Conditions:** The Inflatable Rescue Cushion may be placed on almost any surface including gravel and kerbstones, although very sharp objects and glowing embers should be avoided.

**Moving the Rescue Cushion:** Carrying points on all four sides enable even the largest inflated cushion to be easily moved and finely positioned.

|                        | SP 16                            | SP 23               | SP40                 |
|------------------------|----------------------------------|---------------------|----------------------|
| <b>L X B X Ht</b>      | 3.5 x 3.5 x 1.7 m                | 4.5 x 4.5 x 2.3 m   | 8.5 x 8.5 x 3.7 m    |
| <b>Ground required</b> | 3.8 x 3.8 m                      | 4.9 x 4.9 m         | 9 x 9 m              |
| <b>Deployment</b>      | 2 persons / 30 secs              | 4 persons / 60 secs | 4 persons / 120 secs |
| <b>Max Jump</b>        | 16 m                             | 23 m                | 40 m                 |
| <b>Recovery time</b>   | 10 secs                          | 20 secs             | 20 secs              |
| <b>Inflation</b>       | 1x 6L / 300 bar cyl              | 1x 8L / 300 bar cyl | 5x 6L / 300 bar cyl  |
| <b>Connection</b>      | As brigade standard air cylinder |                     |                      |
| <b>Weight</b>          | 55 kg (with cyl)                 | 80 kg (with cyl)    | 250 kg (with cyl)    |
| <b>Packed</b>          | 900 x 550 x 300 mm               | 1250 x 650 x 500 mm | 1700 x 950 x 750 mm  |
| <b>Compliance</b>      | DIN 14151, 1-3                   |                     |                      |
| <b>Code:</b>           | CT096                            | CT097               | CT099                |



Watch the video:





# BCB MANUFACTURING



Celebrating Managing Director Andrew Howell's 40 years of successful international business at BCB International Ltd.

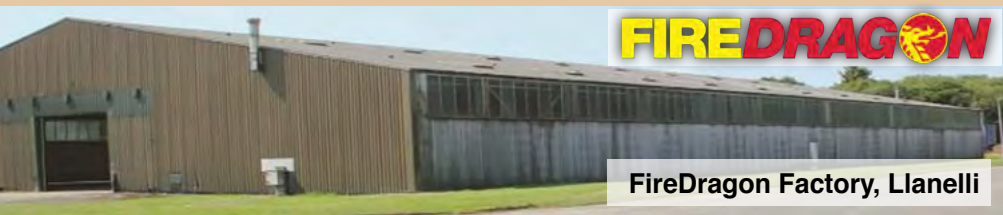
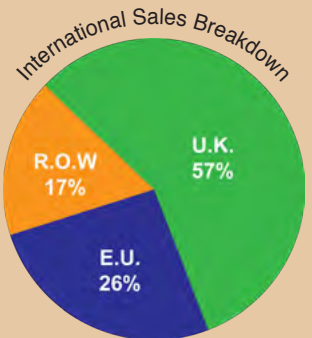

An award winning company:



The Queens Award for Export Achievement





## OTHER RANGES FROM BCB:

### MARINE



### CAMPING & OUTDOORS



### HUMANITARIAN AID EQUIPMENT



### SURVIVOR

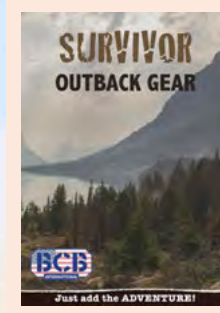

### POLICE & SECURITY



166 YEARS OF LIFESAVING INNOVATION

Tel: +44 (0)29 20 433 700

Email: [Info@bcbint.com](mailto:Info@bcbint.com)

Web: [www.bcbint.com](http://www.bcbint.com)

BCB International Ltd.  
Howell House,  
Lamby Industrial Park,  
Cardiff,  
CF3 2EX  
Great Britain